

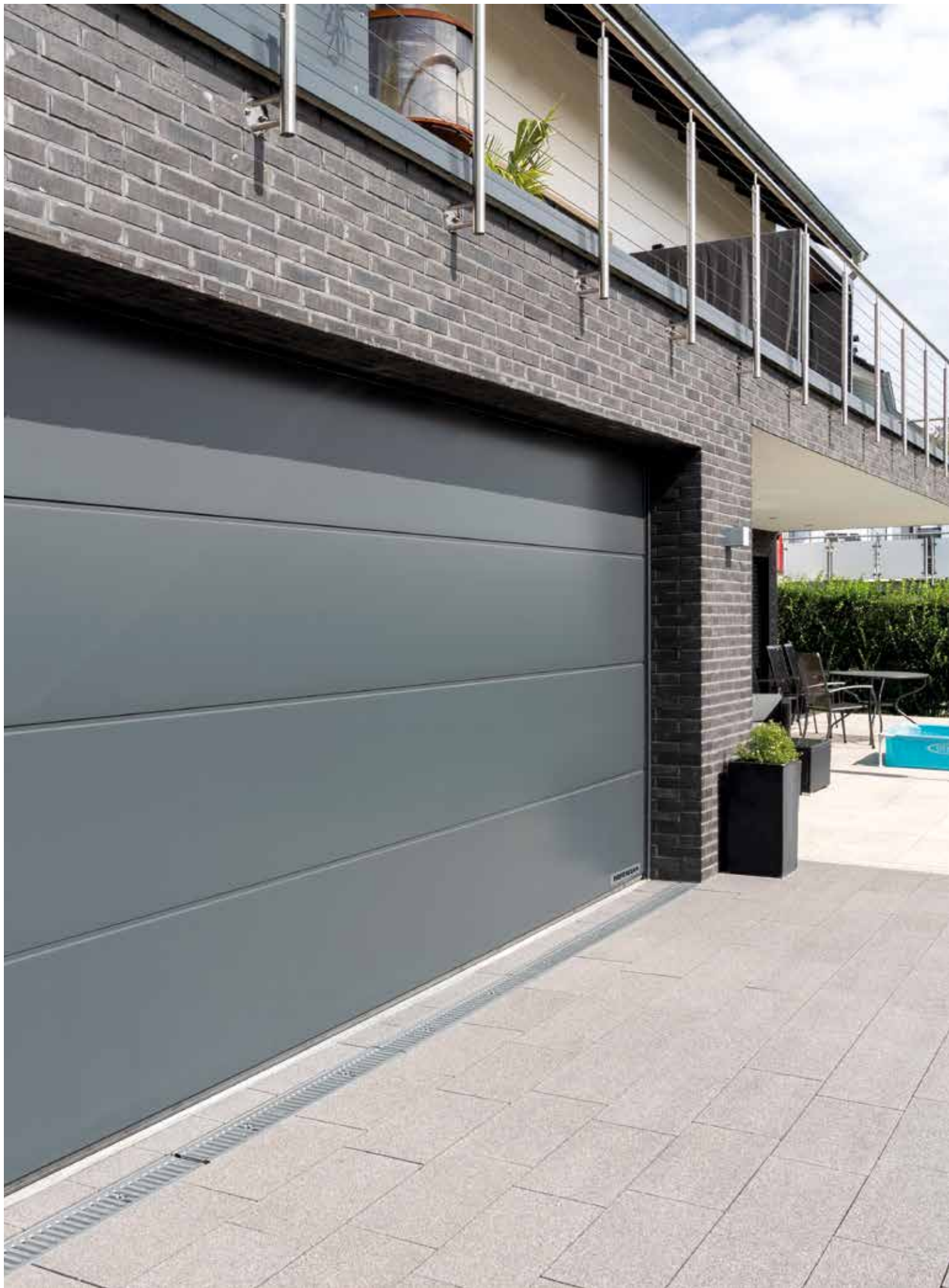

SECTIONAL GARAGE DOORS

NEW. Slategrain surface finish with slate structure in 15 preferred colours and RAL to choose

HÖRMANN





4

Good reasons
to try Hörmann
sectional doors.



16

Inspirations.



50

Design.
Equipment.
Accessories.

Responsibility for generations.

The family business has over 85 years of experience as a construction component specialist. This gives us an obligation to both past, current and future generations.

That's why environmental responsibility plays such an important role for us.

With this in mind, we develop innovative solutions for sustainable products and intelligent environmental protection.



“A GOOD REPUTATION MUST BE EARNED.”

August Hörmann

In keeping with the tradition started by the company's founder, the Hörmann brand is a true promise of quality and, with sales of over 20 million doors and operators, is one of Europe's most successful suppliers. Due to the comprehensive international sales and service network, Hörmann is your strong partner for high-quality construction components.

AN EYE ON THE FUTURE. Hörmann is setting a good example. That's why 100% of our electricity needs in Germany come from green electricity. Together with an intelligent and certified energy management system, CO₂-neutral mailing and the recycling of valuable materials, more than 40000 tonnes of CO₂ are saved each year. In addition, we offset over 100000 tonnes of CO₂ by promoting wind energy and reforestation projects in cooperation with Climate Partner.



You can find further information
at www.hoermann.de/umwelt



Brand quality made in Germany



The family-owned company Hörmann offers all important construction components for building and renovating projects from a single source. We manufacture in highly specialised factories using state-of-the-art production technologies. Our employees work intensively on new products, continual further developments and improvements to details. The results are patents and unique products on the market.





10-year warranty*

LONG-LASTING. GUARANTEED. All major door and operator components are developed and manufactured by Hörmann. Endurance tests under real conditions ensure mature series products with Hörmann quality. Thanks to this and uncompromising quality assurance, you receive a 10-year warranty on all Hörmann sectional doors and a 5-year warranty on Hörmann operators*.

* The complete warranty conditions can be found at: www.hormann.co.uk



Tested and certified

CERTIFIED SAFETY FOR YOU AND YOUR FAMILY.

Hörmann sectional doors are tested and certified in accordance with the high safety requirements of European standard 13241, not only on their own but also in combination with Hörmann operators. It would be hard to find a safer sectional door. And this provides you and your family with safety during daily use.



Space-saving opening and secure closing.

Sectional garage doors open vertically upwards and are suspended under the ceiling to save space. This construction principle means you can make full use of the space inside and in front of the garage. Sectional garage doors can be fitted in any garage opening and offer an extra passage width. Treat yourself to this comfort and convenience.





CERTIFIED RC 2 SECURITY EQUIPMENT.

In addition to the standard anti-lift kit, which automatically locks your door securely and protects it against being forced open, the garage sectional door LPU 67 Thermo and optionally the LPU 42, wicket as well as side doors come with certified RC 2 security equipment as standard.

→ For further information, see from page 71.



Take a look at the video
“Reassuring security” at:
www.hormann.co.uk/videos



MORE PASSAGE WIDTH. Sectional doors with a passage width extended by up to 14 cm also make it much easier to park modern, larger vehicles and SUVs (see centre picture). With older up-and-over doors, driving in and out is often a matter of millimetres (see bottom picture).



Intelligent operating comfort.

Control your garage door and entrance gate operators, door operators, entrance door locks, lights and other devices simply, safely and conveniently via hand transmitter, radio switch or smartphone. All operators, receivers and controls with BiSecur radio technology are 100 % compatible with each other.





Only from Hörmann

CERTIFIED SECURITY. The bidirectional radio system BiSecur with particularly secure encryption protocol and stable, interference-free range makes sure that no one can copy your radio signal. This is also confirmed by the security experts of Bochum University and independent test institutes.



Watch the video on YouTube or at www.hormann.co.uk/videos

INTELLIGENT TECHNOLOGY. Hörmann operators convince with more convenience, smart functions and intelligent technology. The automatic safety cut-out stops the door securely and reliably if it encounters an obstacle. Your door opens and closes quietly and smoothly with the soft start and soft stop. Our elegant hand transmitters allow you to open your door from your car. Or use your smartphone as a door opener with the Hörmann BlueSecur app or the Hörmann homee smart home system.

→ For further information, see from page 76.

Thanks to the standard automatic safety cut-out, children can play in your yard without worrying.



With the Homee smart home system, you can control all door functions via your tablet or smartphone.



Choose the door that suits your home.

No matter the architectural style, with Hörmann, you are guaranteed to find a sectional garage door design to fit your personal style and home – from straight-lined ribbing to classic panelling in many surface finishes, colours and decors, as well as solid timber doors. Be inspired by the Hörmann variety on the following pages or configure your desired door conveniently on the internet.





THE DOOR OF YOUR CHOICE IN JUST A FEW CLICKS.

With the door configurator, you can conveniently test many design and product variations on your own PC or tablet in advance. You can put your dream door together in just a few clicks by selecting the door type, surface finish, colour and size and also see the recommended retail price of your configuration. If you then upload a picture of your house and place the door in your garage opening, you can see in advance how well your new garage door will match your home.



The Hörmann configurator can be found at:
[www.hormann.co.uk/home-owners-and-renovators/
configurator](http://www.hormann.co.uk/home-owners-and-renovators/configurator)



GERMANY'S BEST-SELLING GARAGE DOOR.

More than 5 million customers are convinced of the convenience, safety and design of Hörmann sectional garage doors.





16 L-ribbed

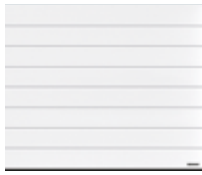

24 M-ribbed



34 S-ribbed



36 D-ribbed



36 T-ribbed



40 S-panelled



42 Solid timber doors

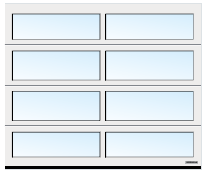

44 Glazed doors



46 Special doors



48 Hinged garage doors







PLANAR SURFACE FINISH. The elegant surface finish in 6 exclusive Matt deluxe Hörmann colours meets all expectations of a modern door design. It impresses by combining a smooth surface finish with fine elegance and matt trendy colours.

→ Available as L-ribbed. For all colours and details, see from page 62.



L-ribbed

PAGE 16 / 17. Planar, CH 703 Matt deluxe Anthracite metallic

LEFT. Planar, CH 7016 Matt deluxe Anthracite grey, 3000 mm door height

BOTTOM LEFT. Detail Planar, CH 9006 Matt deluxe White aluminium

BOTTOM RIGHT. Planar CH 9006 Matt deluxe White aluminium.
Aluminium entrance door ThermoCarbon style 860
in White aluminium RAL 9006





DURAGRAIN SURFACE FINISH. With this smooth door surface, you can choose from 24 detailed, natural and true-colour decors or, if you wish, have your door printed with an individual image. The final coating of high-strength protective paint is especially robust, scratch-resistant and stain-resistant. As a result, your door maintains its attractive look.

→ Available as L-ribbed. For all decors and details, see from page 64.





L-RIBBED

TOP LEFT. Duragrain concrete

TOP RIGHT. Duragrain Rusty Steel

BOTTOM. Duragrain Mocca

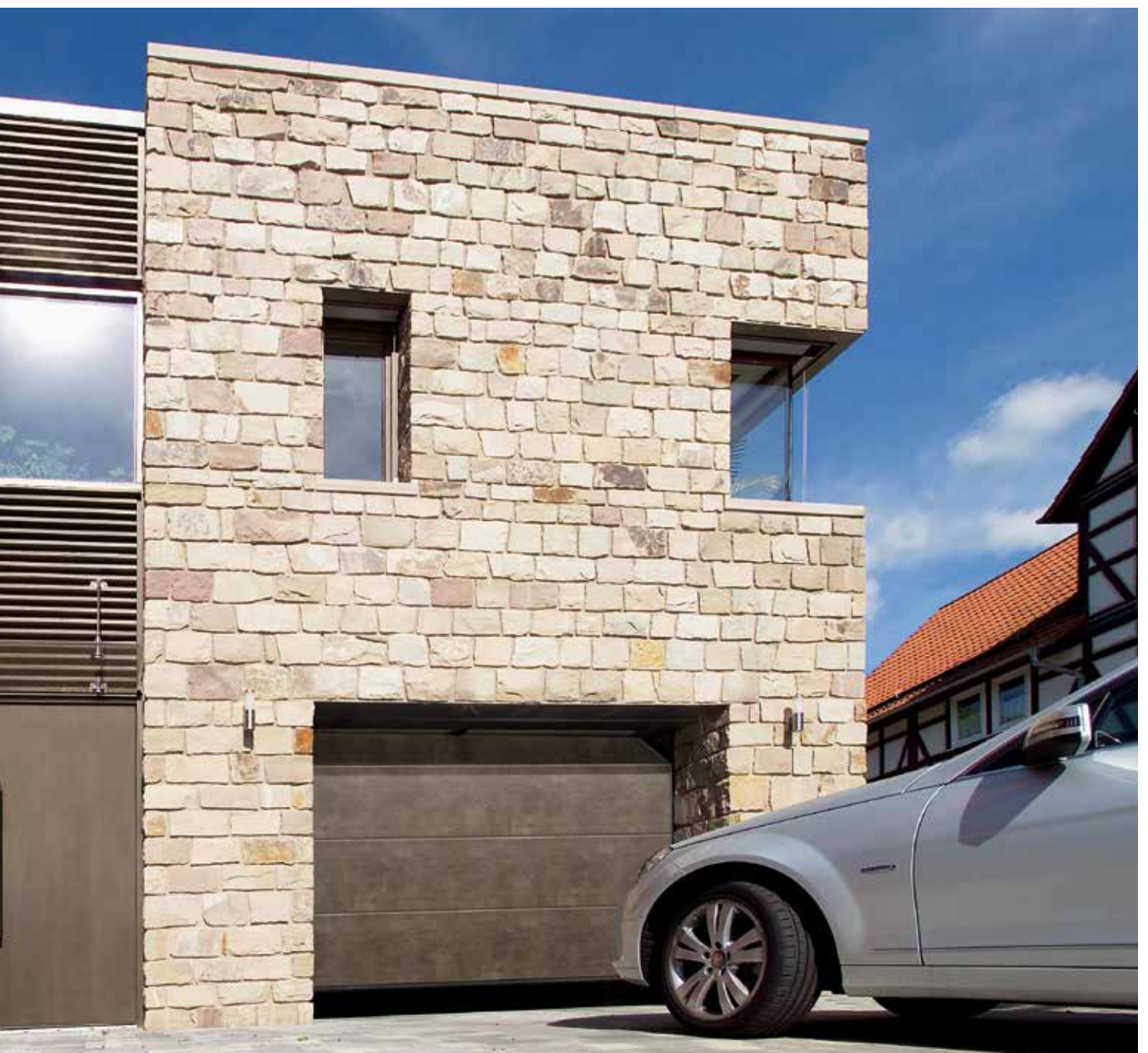



INTELLIGENT ACCESSORIES. You no longer have to go out in any wind and weather to check if your door is closed. At the press of a button, the colour of the LED on the hand transmitter HS 5 BS or the internal push button FIT 5 BS indicates the position of the door. If required, another push of a button* closes the door. It is the most convenient and secure way to control your door.

→ The accessories are available for all sectional garage doors.

* An additional photocell is required for operation without visual contact to the door.



Further information can be found in the "Door operators and Smart Home systems" brochure.



TOP. L-ribbed Silkgrain,
Anthracite grey RAL 7016.
Aluminium entrance door
ThermoSafe style 504 in
Anthracite grey RAL 7016

RIGHT. M-ribbed Silkgrain,
Traffic white RAL 9016



LIGHT SOLUTIONS. An LED light strip puts your door and side door in the right light. Hörmann key switch posts offer you more light and security in your yard entrance.





M-ribbed



PAGE 24 / 25. Silkgrain, Anthracite grey RAL 7016; Hörmann aluminium entrance door ThermoSafe, style 861, Anthracite grey RAL 7016

TOP LEFT. Woodgrain, Window grey RAL 7040

TOP RIGHT. Woodgrain, Slate grey RAL 7015 ■ **NEW**

BOTTOM LEFT. Woodgrain, Traffic white RAL 9016

BOTTOM RIGHT. Detail view of Woodgrain, Traffic white RAL 9016





WOODGRAIN SURFACE FINISH. On this inexpensive and robust surface with an authentic sawn timber look, minor scratches can be easily repaired.

→ Available as L-, M- and S-ribbed as well as S-panelled.
For all colours and details, see from page 60.

SLATEGRAIN SURFACE FINISH ■ NEW. Slate slabs are the model for this new textured surface finish that gives your door a special look.

→ Available as L- and M-ribbed. For all colours and details, see from page 60.





M-RIBBED

TOP LEFT. Detail view of Slategrain Traffic white RAL 9016

BOTTOM LEFT. Slategrain, Anthracite grey RAL 7016

TOP RIGHT. Slategrain, Traffic white RAL 9016

BOTTOM RIGHT. Slategrain, Anthracite grey RAL 7016





DECOGRAIN SURFACE FINISH.

The detailed surface finish is available in five natural-looking timber designs and with an anthracite metallic effect. Your door remains beautiful for a long time thanks to the special surface protection with UV-resistant plastic film coating on the outside of the steel sections.

→ Available as L- and M-ribbed.
For all decors and details,
see from page 63.





M-RIBBED

TOP LEFT. Detail Decograin Golden Oak

TOP CENTRE. Decograin Golden Oak

TOP RIGHT. Decograin Dark Oak

BOTTOM. Decograin Titan Metallic CH 703





TOP. L-ribbed, Silkgrain, Basalt grey RAL 7012
■ **NEW** with matching side door

BOTTOM LEFT. Single-leaf multi-purpose door
MZ Thermo, Traffic white RAL 9016

BOTTOM RIGHT. M-ribbed, Woodgrain,
Anthracite grey RAL 7016 with wicket door





SIDE DOORS. The door as a second entrance to your garage is available in the same surface finishes, colours and decors as your garage door – if desired, also with exactly the same alignment of the ribbing. This ensures that everything fits together. If you value good thermal insulation and also want to reduce the risk of condensation forming on the inside, a multi-purpose door MZ Thermo with thermal break is the best choice for you.

→ For further information, see from page 72.

WICKET DOORS. A wicket door in the garage door lets you easily access gardening tools, bikes or wheelbarrows in your garage. The wicket door features a stainless steel threshold that is merely 10 mm high in the centre and 5 mm high at the sides. This reduces the risk of tripping and makes it easier to wheel things through.

→ For further information, see from page 74.





INEXPENSIVE PREFERRED COLOURS. Design your home according to your wishes with 15 preferred colours or in RAL to choose.

→ Available for the Woodgrain, Slategrain and Silkgrain surface finishes. For all colours and details, see from page 60.

S-ribbed



LEFT. Woodgrain, Fir green RAL 6009

BOTTOM. Woodgrain, Anthracite grey RAL 7016



D-ribbed | T-ribbed



SILKGRAIN SURFACE FINISH.

Thanks to its elegant door appearance, this silky smooth surface finish is the first choice for modern architecture.

→ Available as L-, M-, D- and T-ribbed.
For all colours and details, see from page 60.

LEFT. T-ribbed, Silkgrain, Stone grey RAL 7030,
Aluminium entrance door ThermoSafe style 860
in Stone grey RAL 7030

RIGHT. D-ribbed, Silkgrain, Anthracite grey RAL 7016.
Aluminium entrance door ThermoSafe style 860
in Anthracite grey RAL 7016

BOTTOM. Detail Silkgrain, Stone grey RAL 7030



INLAY DESIGN ELEMENTS.

Give your door a very personal touch. The inlays in stainless steel or timber look as well as individually in RAL to choose are inserted into the ribbing of the sectional doors entirely according to your wishes (figure bottom left).

→ Available for M-, D- and T-ribbed. For all designs and details, see from page 57.

RIGHT. Design style 461, Silkgrain CH 703 Anthracite metallic ■ **NEW** with glazing elements; Hörmann aluminium entrance door ThermoSafe style 173, CH 703 Anthracite metallic

BOTTOM LEFT. T-ribbed, Silkgrain, Stone grey RAL 7030 style 501 with inlay in timber look

BOTTOM RIGHT. Silkgrain, Anthracite grey RAL 7016 with design element "House number"





DESIGN ELEMENTS. Give your door a very special style. Choose one of our design styles or arrange and combine the brushed stainless steel design elements according to your wishes. House numbers or street names are possible as well.

→ Available for L-, D- and T-ribbed. For all designs and details, see from page 56.



LIGHT ELEMENTS. Classic or Sunrise glazings are a perfect match for panelled doors and give your door a special look. But glazings are not only a design element, they also provide daylight in the garage.

→ Available for all door styles.
For all glazings and details,
see from page 59.



S-panelled



TOP LEFT. Woodgrain, Traffic white RAL 9016

TOP CENTRE. Woodgrain, Terra brown RAL 8028

TOP RIGHT. Decograin Golden Oak

BOTTOM. Woodgrain, Moss green RAL 6005
with classic glazing S2 in sandwich version



Solid timber doors

NATURALLY BEAUTIFUL. These doors with a smooth or brushed surface are excellently suited for timber houses or buildings with many timber elements, such as timber framing or facade elements. Choose from 9 door styles or design your own timber door: With the help of a computer milling machine, we will manufacture your individual door.

→ For further information, see from page 66.





TOP RIGHT. S-ribbed with solid timber panels in Hemlock

BOTTOM RIGHT. M-ribbed with solid timber panels in Hemlock

LEFT. Door style 405, painted white on site with hinged door fittings and decorative handles

Glazed doors

ALUMINIUM FRAME DOOR ART 42 / ART 42 THERMO.

This door version with standard profile or profile with thermal break convinces with more light in the garage or with better ventilation in the parking boxes of collective garages if grille infills are used.

→ For further information, see from page 58.





TOP. ALR F42 Vitraplan, brown tinted

LEFT. ART 42 Thermo with synthetic double panes, grey tinted

INDUSTRIAL SECTIONAL DOOR ALR F42 VITRAPLAN.

The door is especially elegant thanks to surface-mounted, flush-fitting glazing. The frame profile is concealed, so nothing detracts from the overall appearance.



For further information,
please see the "Industrial sectional doors" brochure.



Special doors

INDUSTRIAL SECTIONAL DOOR ALR F42 FOR ON-SITE CLADDING FLUSH WITH THE FACADE. Design your sectional door according to your wishes with timber, metal, ceramics, plastic and many other materials. The door basis for facade cladding is a Hörmann industrial sectional door ALR F42 with an aluminium frame construction and PU sandwich infill.



For further information, see the planning aid at www.hormann.co.uk/media-centre or seek the expert advice of your Hörmann specialist dealer.

INDUSTRIAL SECTIONAL DOOR SPU F42 PLUS. This door version is the ideal solution for garages up to 7000 mm wide and for special fitting situations where an operator cannot be fitted above the door.



TOP. SPU F42 Plus M-ribbed, Silkgrain, Anthracite grey RAL 7016

LEFT. ALR F42 with on-site, flush-fitting cladding



Hinged garage doors

EASY ACCESS. With the double-leaf hinged garage doors, you can either open both leaves or even just one leaf, in order to get your bike out of the garage, for example. Enjoy maximum comfort by equipping your hinged garage door with an operator. The thermally insulated sections provide good insulation and are available in all surface finishes.

→ For further information, see from page 75.

CUSTOMISED LEAF DIVISION. Design your hinged garage door entirely to suit your needs. The door leaves are available in both symmetrical and asymmetrical division. The symmetrical division, with door leaves of equal width, offers a harmonious door appearance. In the asymmetrical division*, the traffic leaf comes in a width of 870 mm, which allows easy pedestrian passage into the garage. The width of the fixed leaf results from the total width of the door. You can also choose to position the traffic leaf on the left or right side of the door.

* Up to 2000 mm door width

LEFT. M-ribbed, Woodgrain, Traffic white RAL 9016

BOTTOM. S-ribbed, Woodgrain, Light grey RAL 7035







52

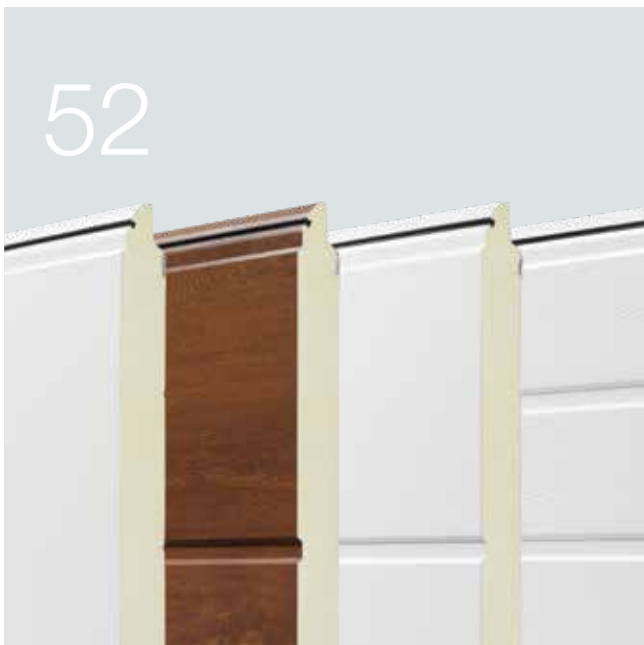

60

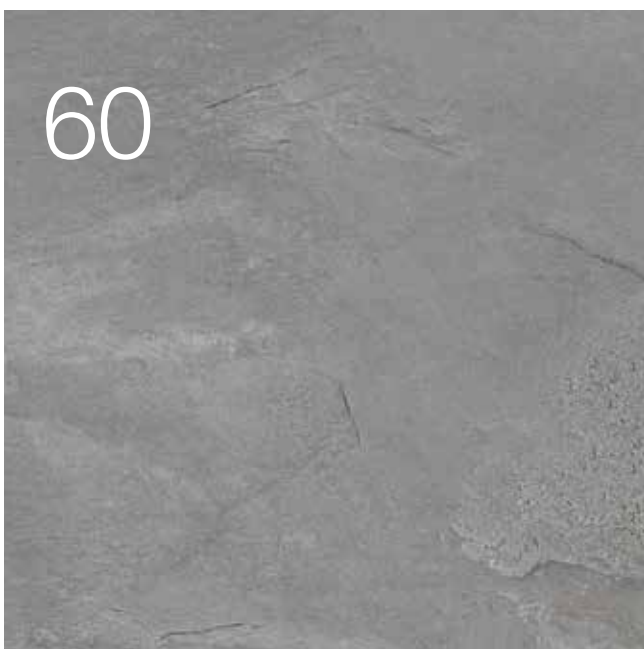

76



Design. Equipment. Accessories.

- 52 Steel sectional doors
- 58 Aluminium frame doors
- 59 Glazings
- 60 Surface finishes, colours, decors
- 66 Solid timber sectional doors
- 68 Equipment
- 72 Side doors
- 74 Wicket doors
- 75 Hinged garage doors
- 76 Operators
- 78 Accessories
- 80 Modernisation solutions
- 84 Dimensions and fitting data

Steel sectional doors

Door leaf versions



LPU 67 Thermo

- Energy-saving door with excellent thermal insulation
- 67 mm thick sections with thermal break
- RC 2 security equipment as standard

LPU 42

- Good insulation and door travel properties
- Double-skinned 42 mm thick sections
- Optional RC 2 security equipment

LTE 42

- Inexpensive solution for free-standing garages
- Single-skinned sections
- No thermal insulation

Surface finishes

Woodgrain, Slategrain and Silkgrain in Traffic white RAL 9016 and 15 preferred colours



Sandgrain in 4 colours



Planar in 6 colours



Decograin in 6 decors



Duragrain in 24 decors



| | LPU 67 Thermo | LPU 42 | LTE 42 |
|---|--|---|--|
| Performance characteristics according to European standard 13241 | | | |
| Section material | Galvanised sheet steel with polyester primer coating | Galvanised sheet steel with polyester primer coating | Galvanised sheet steel with polyester primer coating |
| Section thickness | Double-skinned, 67 mm | Double-skinned, 42 mm | Single-skinned |
| Thermal insulation U-value fitted door | 1.0 W/(m ² ·K) ¹⁾ | 1.4 W/(m ² ·K) ¹⁾ | 6.5 W/(m ² ·K) ¹⁾ |
| Acoustic insulation | Approx. 25 dB | Approx. 25 dB | Approx. 20 dB |
| Wind load ⁵⁾ | Class 3 | Class 3 | Class 2 |
| Air/water tightness | Class 3 ⁴⁾ / Class 3 ³⁾ | Class 3 ⁴⁾ / Class 3 ³⁾ | Class 0 ²⁾ / Class 0 ²⁾ |
| Max. width Max. height | 5000 mm 3000 mm | 6000 mm 3000 mm | 5000 mm 3000 mm |
| Styles / surface finishes | | | |
| S-ribbed | | Woodgrain | Woodgrain (Traffic white RAL 9016) |
| M-ribbed | Silkgrain, Decograin (3 decors) | Woodgrain, Slategrain, Silkgrain, Sandgrain, Decograin | |
| L-ribbed | Silkgrain, Decograin (3 decors) | Woodgrain, Slategrain, Silkgrain, Sandgrain, Planar, Decograin, Duragrain | |
| D-ribbed | | Silkgrain | |
| T-ribbed | | Silkgrain | |
| S-panelled | | Woodgrain, Decograin | Woodgrain (Traffic white RAL 9016) |

¹⁾ The U-values apply to fitted doors without glazing with the dimensions 5000 × 2250 mm

²⁾ Doors with ventilation slots, classes 2 – 3 on request

³⁾ Up to 70 Pa water pressure

⁴⁾ Available for panelling and L-ribbing (LPU 42 doors with S-, M-, D- or T-ribbing as well as with wicket door: class 2)

⁵⁾ Higher wind load classes on request

Steel sectional doors

Door leaf construction



Standard styles



S-ribbed (LPU 42, LTE 42), Traffic white RAL 9016



M-ribbed (LPU 67 Thermo, LPU 42, LTE 42), Traffic white RAL 9016



D-ribbed (LPU 42), Traffic white RAL 9016

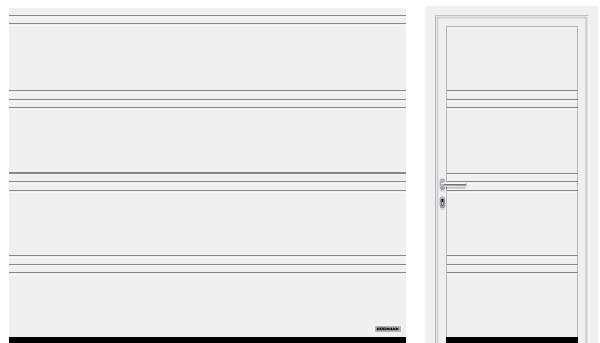

T-ribbed (LPU 42), Traffic white RAL 9016



L-ribbed (LPU 67 Thermo, LPU 42), Traffic white RAL 9016



S-panelled (LPU 42, LTE 42), Traffic white RAL 9016

Steel sectional doors

Design elements

Styles with design elements



L-ribbed (LPU 67 Thermo, LPU 42), Traffic white RAL 9016, design element style 450, matching side door

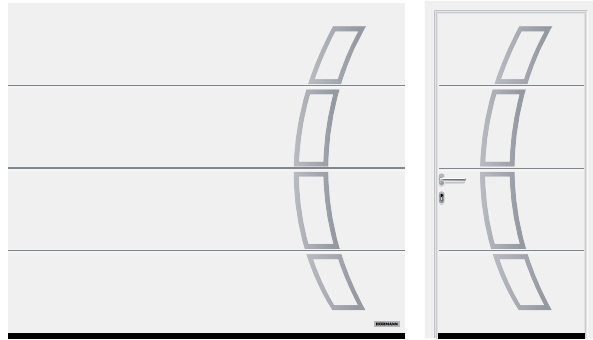

L-ribbed (LPU 67 Thermo, LPU 42), Traffic white RAL 9016, design element style 457, matching side door

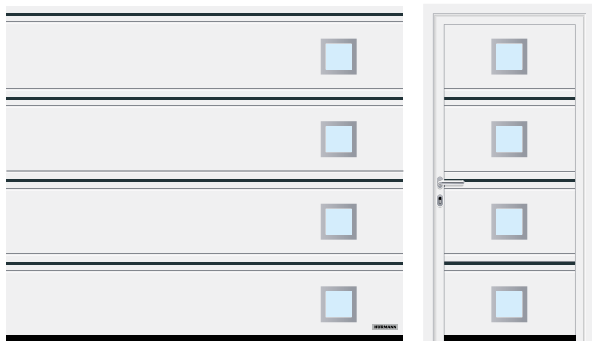

T-ribbed (LPU 42), Traffic white RAL 9016, inlay design element style 501 and design element style 461 Anthracite grey RAL 7016, matching side door

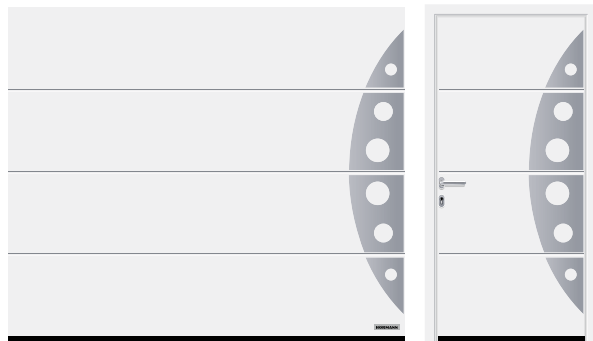

L-ribbed (LPU 67 Thermo, LPU 42), Traffic white RAL 9016, design element style 458, matching side door

Design elements

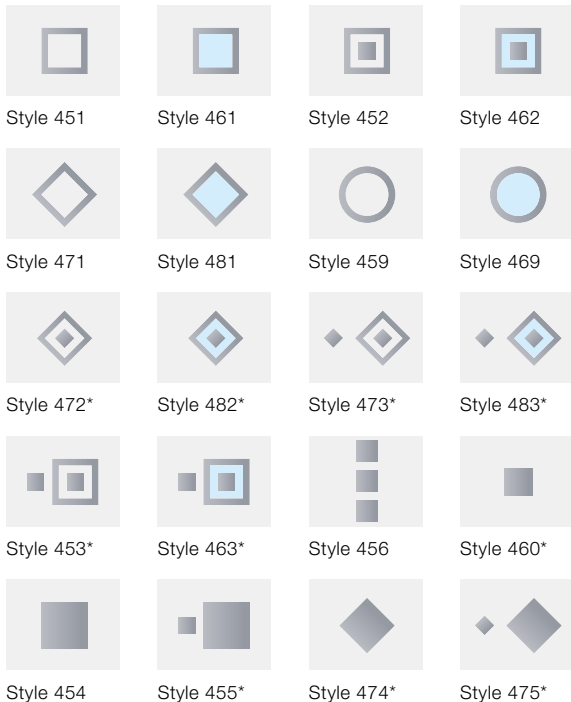

* Only LPU 42

Glazings



Design element in brushed stainless steel with optional real glass for styles 461* and 481*

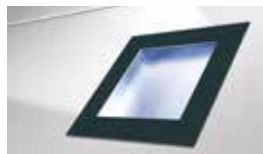

Design element painted in Anthracite grey RAL 7016 with synthetic glazing for styles 461, 462, 463, 469, 481, 482 and 483

Styles with inlay design elements



T-ribbed (LPU 42), Traffic white RAL 9016,
inlay design element style 500 with divided inlays in timber look



D-ribbed (LPU 42), Traffic white RAL 9016,
inlay design element style 502 in Steel blue RAL 5011

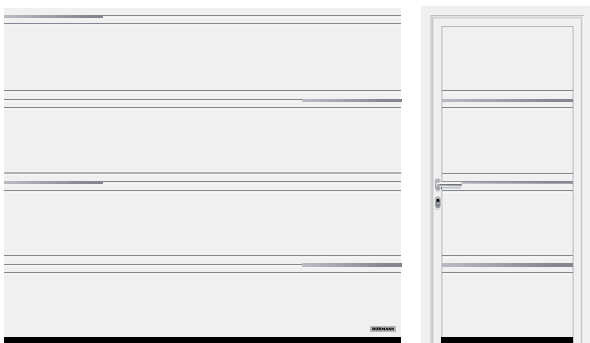

T-ribbed (LPU 42), Traffic white RAL 9016,
inlay design element style 503 in stainless steel look



M-ribbed (LPU 42), Traffic white RAL 9016,
inlay design element style 504 in timber look, in the wicket door

Inlay design elements



Stainless steel look



Timber look



RAL to choose (shown in RAL 9005)

Design elements "Numbers and words"

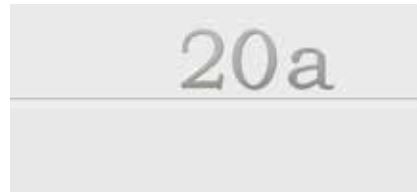

Positive view, modern font



Negative view, classic font

Aluminium frame doors

ART 42 / ART 42 Thermo

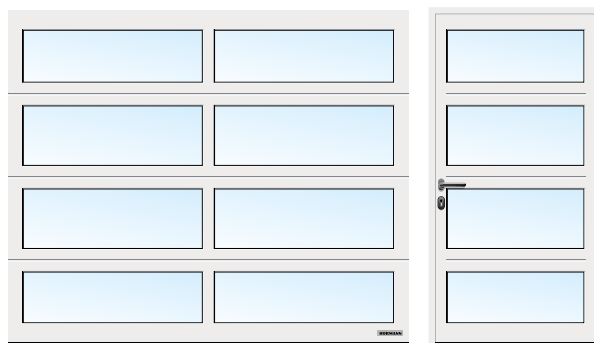

ART 42 glazed, Traffic white RAL 9016

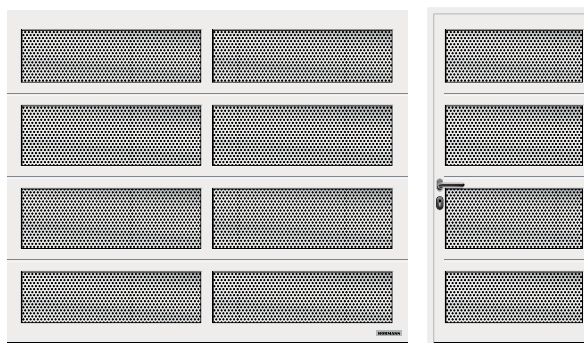

ART 42 with perforated sheet, Traffic white RAL 9016

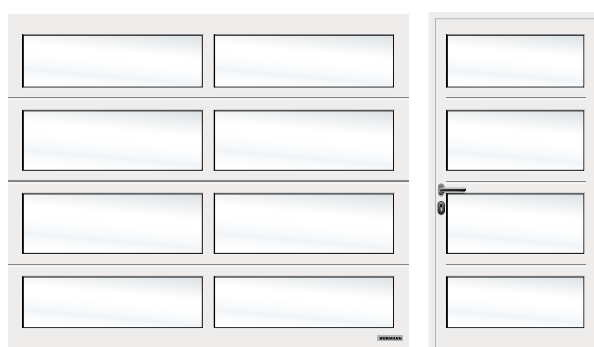

ART 42 glazed white tinted, Traffic white RAL 9016

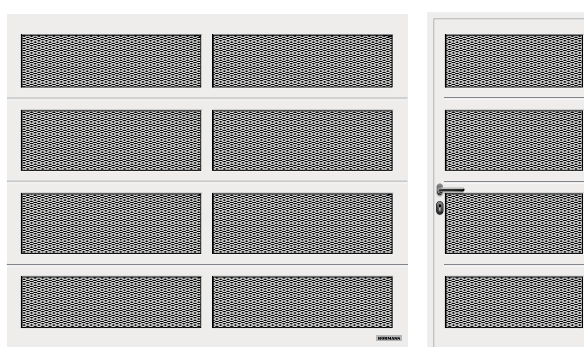

ART 42 with expanded mesh, Traffic white RAL 9016

Section view



ART 42

ART 42 Thermo

ART 42 / ART 42 Thermo

| | |
|---|---|
| Frame material | Aluminium |
| Frame thickness | 42 mm |
| Thermal insulation ART 42 U-value fitted door | 4.0 W/(m ² ·K) ¹⁾ |
| Thermal insulation ART 42 Thermo U-value fitted door | 3.4 W/(m ² ·K) ¹⁾ |
| Acoustic insulation | R = approx. 20 dB |
| Wind load ³⁾ | Class 2 |
| Air/water tightness | Class 3 ²⁾ / Class 3 ²⁾ |
| Max. width | 5500 mm |
| Max. height | 3000 mm |

¹⁾ The U-values apply to fitted doors without glazing with the dimensions 5000 × 2250 mm

²⁾ Doors with ventilation slots, classes 2 – 3 on request

³⁾ Higher wind load classes on request

Glazing variations



1



2



3

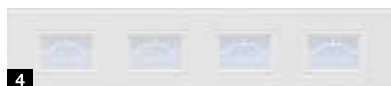

4



5



6



7



8



9

Glazing variants for steel sectional doors

- 1 Classic glazing S0 ¹⁾
- 2 Classic glazing M0 ¹⁾
- 3 Classic glazing L0 ¹⁾
- 4 Classic glazing S1
- 5 Classic glazing S2
- 6 Sunrise glazing S10 ³⁾
- 7 Sunrise glazing S60 ⁴⁾ (left door half shown)
- 8 Glazing type D ¹⁾
- 9 Aluminium light strips ²⁾

Infill variations for aluminium frame doors and aluminium light strips

- 10 Polycarbonate double pane, clear
Synthetic double pane, clear
- 11 Synthetic double pane, white tinted (opal / clear)
- 12 Synthetic double pane, crystal structure
- 13 Multiple-moulded pane
- 14 Synthetic double pane, brown tinted
- 15 Synthetic double pane, grey tinted
- 16 PU sandwich infill, smooth
- 17 PU sandwich infill, Stucco
- 18 Perforated stainless steel sheet
- 19 Stainless steel expanded mesh
- 20 Crimped mesh
- 21 Welded grille

Glazings (1 to 8, 10) correspond to a door width of 2500 mm

- ¹⁾ Individual arrangement of glazings is possible
- ²⁾ Rails are possible
- ³⁾ Door width 2130 – 2750 mm
- ⁴⁾ Door width 4751 – 5500 mm

Infill variations



10



16



11



17



12



18



13



19



14



20



15



21

Clear synthetic glazing from Hörmann comes as standard with DURATEC glazing.

It offers you decisive advantages:

- A permanently clear view
- Improved thermal insulation

Only from Hörmann



Duratec
Extremely scratch-resistant

Surface finishes, colours, decors

Woodgrain, Slategrain, Silkgrain

Woodgrain



Slategrain ■ NEW



Silkgrain



15 preferred colours

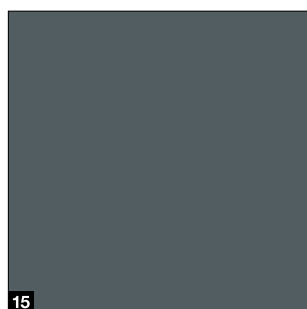
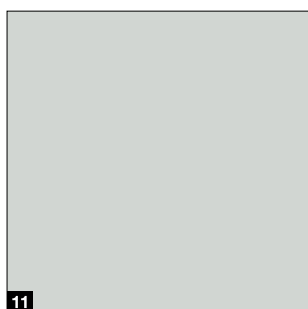
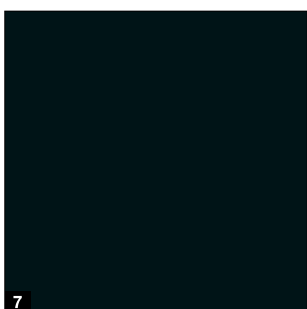
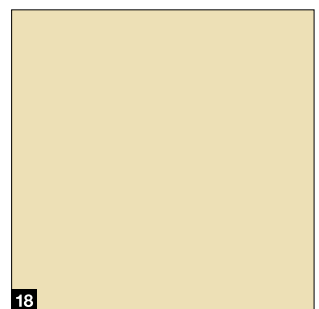
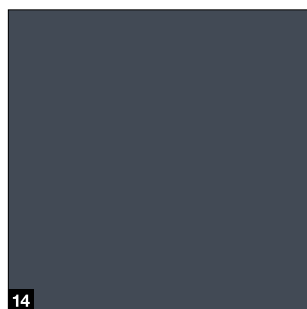
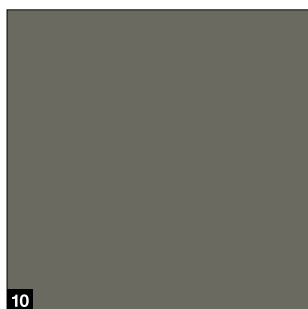
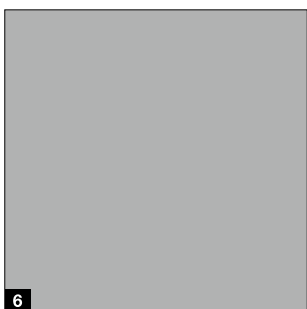
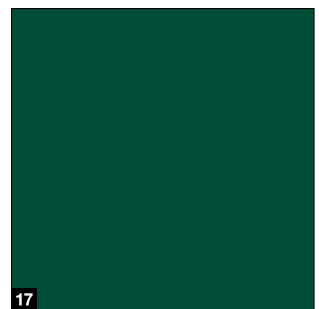
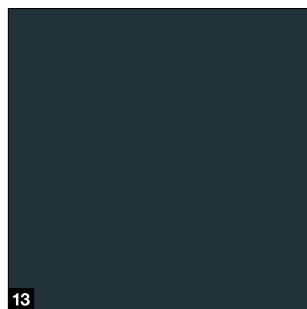
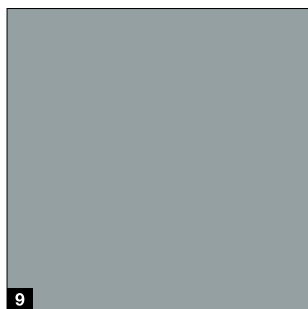
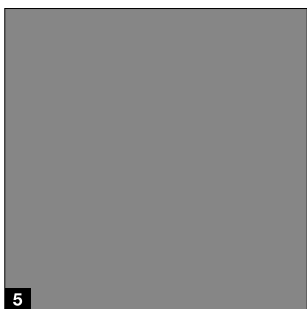
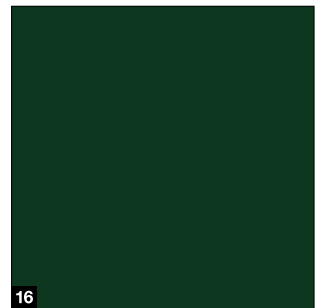
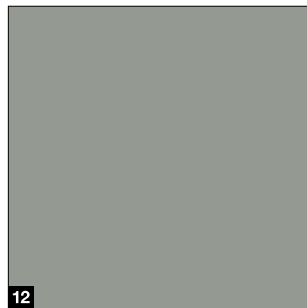
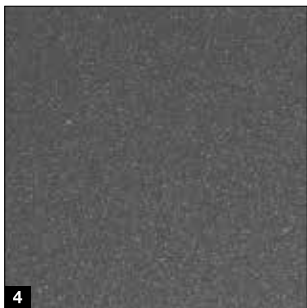

Only from Hörmann

Slategrain surface finish

- 1 **Woodgrain**
RAL 9016 Traffic white
- 2 **Slategrain**
RAL 9016 Traffic white
- 3 **Silkgrain**
RAL 9016 Traffic white

Preferred colours

- 4 CH 703 Anthracite metallic ■ **NEW**
- 5 RAL 9007 Grey aluminium
- 6 RAL 9006 White aluminium
- 7 RAL 9005 Jet black ■ **NEW**
- 8 RAL 8028 Terra brown
- 9 RAL 7040 Window grey
- 10 RAL 7039 Quartz grey ■ **NEW**
- 11 RAL 7035 Light grey
- 12 RAL 7030 Stone grey
- 13 RAL 7016 Anthracite grey
- 14 RAL 7015 Slate grey ■ **NEW**
- 15 RAL 7012 Basalt grey ■ **NEW**
- 16 RAL 6009 Fir green
- 17 RAL 6005 Moss green
- 18 RAL 1015 Light ivory

RAL to choose

The Woodgrain, Slategrain and Silkgrain surface finishes are optionally available in around 200 colours from the RAL colour chart* as well as in many NCS and DB colours.

Please note:

Sectional garage doors are generally supplied in Grey white, RAL 9002, on the inside of the door. Dark colours should not be used for double-skinned steel doors that are exposed to the sun, as possible section deflection may damage the door. All colours based on RAL. The colours and surface finishes shown are subject to the limitations of the printing process and cannot be regarded as binding. Please consult with your local Hörmann specialised dealer.

* RAL Classic colours, with the exception of pearl-effect and fluorescent colours

Protective coatings ■ **NEW** for a long, beautiful door appearance

Final coating. The surface finish of the sections is especially robust, scratch-resistant and stain-resistant thanks to the protective paint.

Final coating "Anti-Graffiti". Due to the protective paint on the surface of the section as well as on glazings, design elements, etc., graffiti can be removed with a commercially available special cleaner.

→ Available for the Woodgrain, Slategrain and Silkgrain surface finishes.



- 1 Double-skinned section
- 2 Galvanisation
- 3 Polyester primer coating
- 4 Final coating or final coating "Anti-Graffiti"

Surface finishes, colours, decors

Sandgrain, Planar, Decograin

Sandgrain

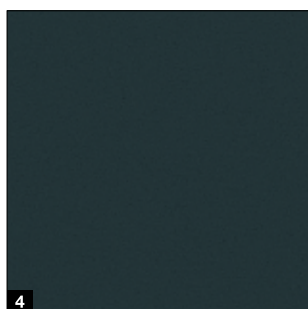

Planar

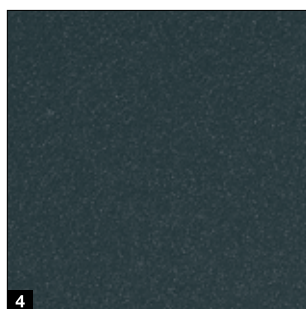
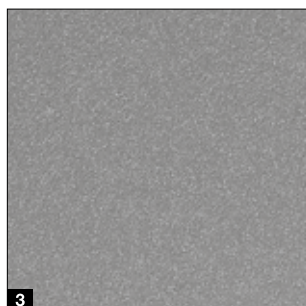
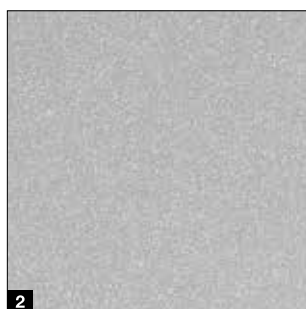
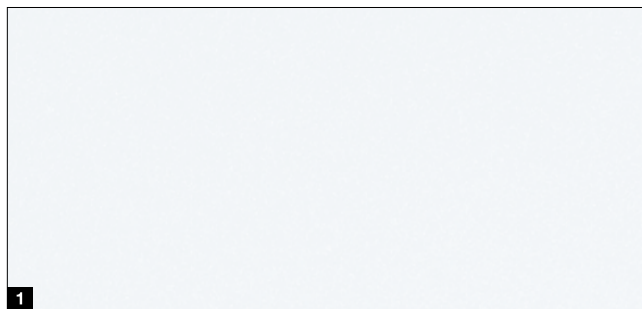

Standard colour

1 RAL 9016 Traffic white

Preferred colours

2 RAL 9006 White aluminium

3 RAL 8028 Terra brown

4 RAL 7016 Anthracite grey

Standard colour

1 CH 9016 Matt deluxe Traffic white

Preferred colours

2 CH 9006 Matt deluxe White aluminium

3 CH 9007 Matt deluxe Grey aluminium

4 CH 7016 Matt deluxe Anthracite grey

5 CH 8028 Matt deluxe Terra brown

6 CH 703 Matt deluxe Anthracite metallic

Decograin

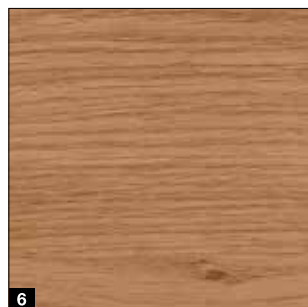
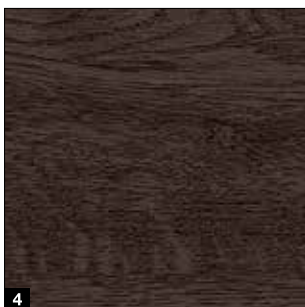
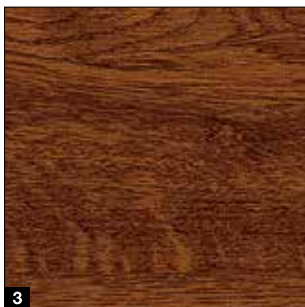

Decograin decors

- 1 Titan Metallic CH 703: anthracite with a metallic effect
- 2 Golden Oak: medium brown, golden yellow oak decor
- 3 Dark Oak: walnut-coloured oak decor
- 4 Night Oak: dark, intense oak design *
- 5 Rosewood: mahogany-coloured timber design *
- 6 Winchester Oak: natural-coloured knotty oak design*

* Not for LPU 67 Thermo

Only from Hörmann

Matching door leaf, fascia panel and side frames
in Woodgrain Traffic white RAL 9016

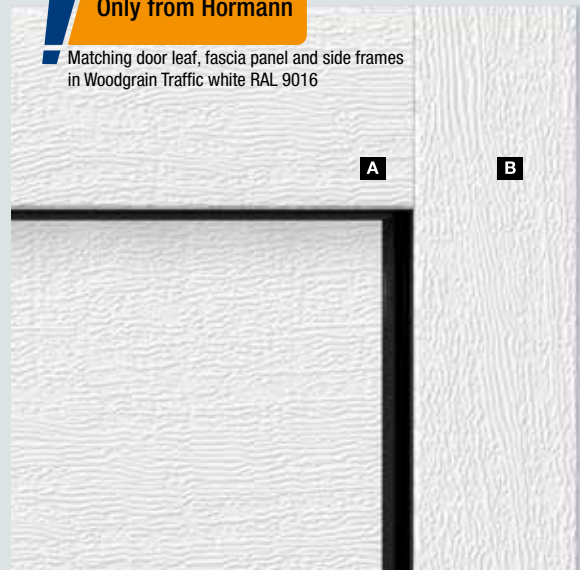

Matching appearance of frames and door leaf

The harmonious appearance of a door is the result of many small details: The fascia panel **A** is always provided matching ¹⁾ the door sections. This ensures that everything fits together. The side frames **B** are available with a white Woodgrain surface finish ²⁾ as standard. With frame coverings, the side frames can be easily adapted to the surface finish of the sections.

→ For further information, see page 80.

¹⁾ For the Slategrain surface finish with smooth surface, for the Duragrain surface finish in a colour matching the door section or in RAL to choose

²⁾ For the LPU 67 Thermo and LPU 42 in premium versions in Grey white RAL 9002

Surface finishes, colours, decors

Duragrain

Duragrain

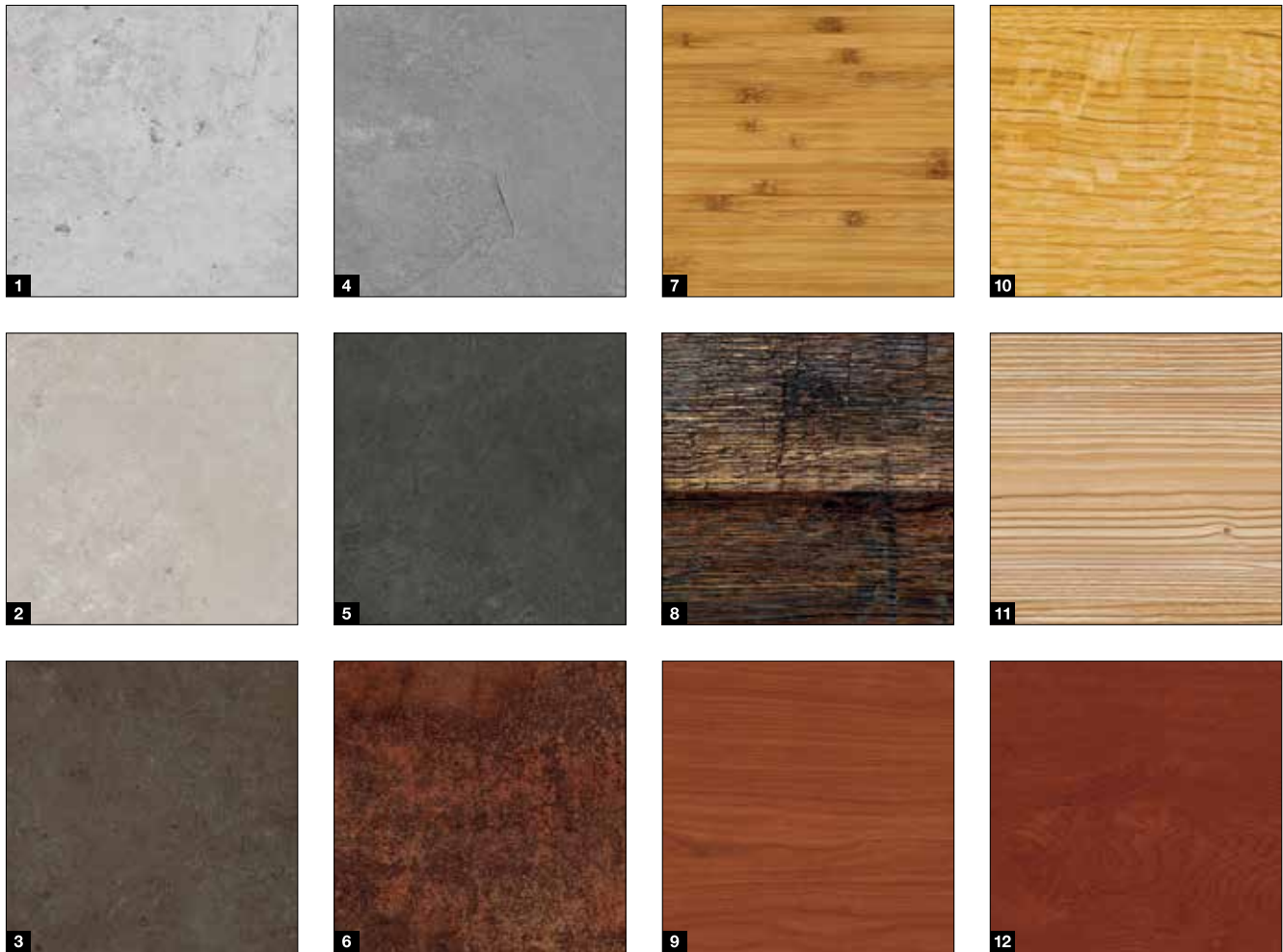

Duragrain
Extremely scratch-resistant

Scratch-resistant and stain-resistant

The innovative digital printing process in combination with the final high-strength protective paint is only available from Hörmann. This is the basis for a permanently beautiful door appearance.

For Duragrain doors, we optionally supply the frame covering and the panels in a colour that matches the decor.

- 1 Double-skinned section
- 2 Galvanization
- 3 Priming
- 4 Innovative digital print
- 5 Final coating with high-strength protective paint



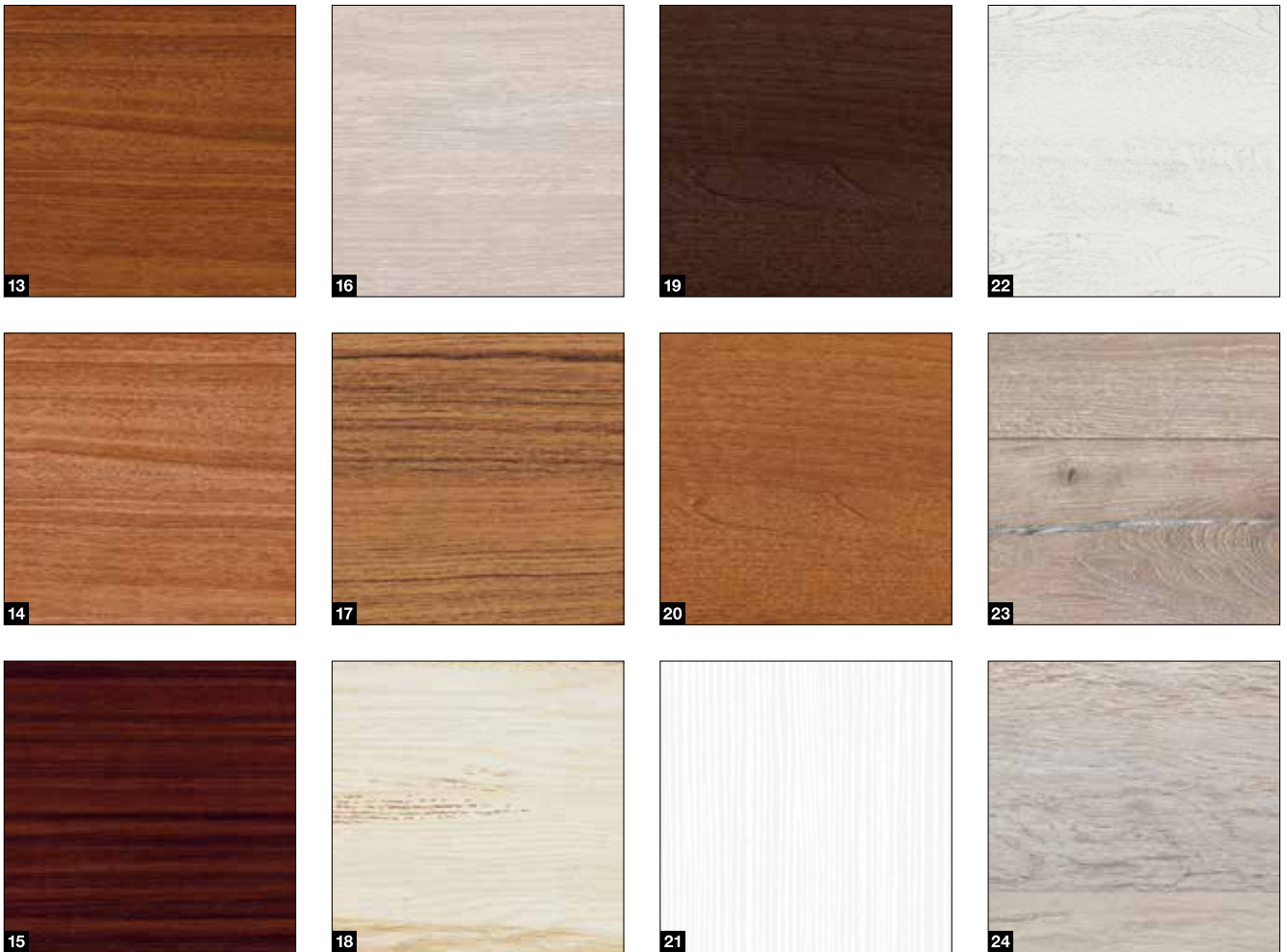

- | | |
|-----------------------|-----------------------------------|
| 1 Concrete | 13 Noce Sorrento Balsamico |
| 2 Beige | 14 Noce Sorrento, plain |
| 3 Mocca | 15 Sapele |
| 4 Grigio | 16 Sheffield |
| 5 Grigio Scuro | 17 Teak |
| 6 Rusty Steel | 18 Weathered Look |
| 7 Bamboo | 19 Terra Walnut |
| 8 Burned Oak | 20 Colonial Walnut |
| 9 Cherry | 21 White Brushed |
| 10 Nature Oak | 22 White Oak |
| 11 Pine | 23 White Oiled Oak |
| 12 Rusty Oak | 24 Whitewashed Oak |

Please note:

Duragrain doors are generally supplied in Grey white, RAL 9002, on the inside of the door. When the door is opened, a thin Grey white stripe can be seen between the sections on the outside.

Side frames and fascia panels are delivered in Woodgrain, Traffic white RAL 9016 as standard. Optionally, you can obtain lintel and frame fascias in a colour matching the decor or in RAL to choose.

Solid timber sectional doors

LTH 42

Standard styles

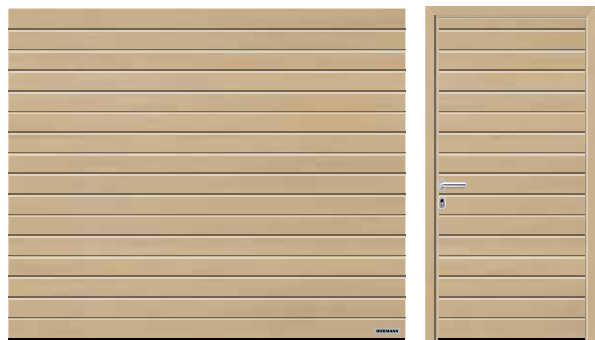

S-ribbed



M-ribbed



L-ribbed

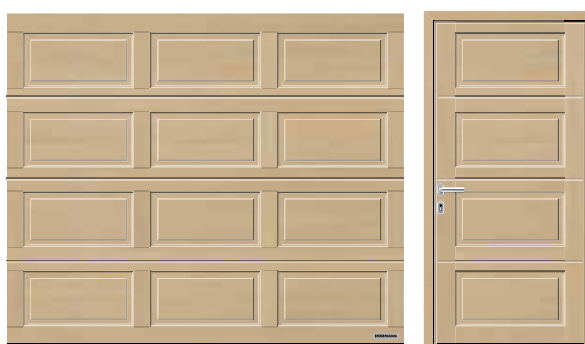

Panelled



LTH 42

| | |
|---|---|
| Section material | Solid timber |
| Section thickness | 42 mm |
| Thermal insulation U-value fitted door | 2.9 W/(m ² ·K) ¹⁾ |
| Wind load ³⁾ | Class 3 |
| Air / water tightness | Class 0 ²⁾ / Class 0 ²⁾ |
| Max. width | 5000 mm |
| Max. height | 3000 mm |

¹⁾ The U-values apply to fitted doors without glazing with the dimensions 5000 × 2250 mm

²⁾ Doors with ventilation slots, classes 2 – 3 on request

³⁾ Higher wind load classes on request

Design styles

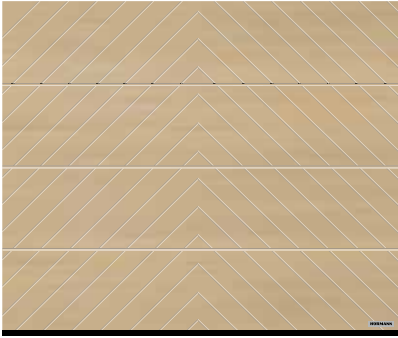

Style 401

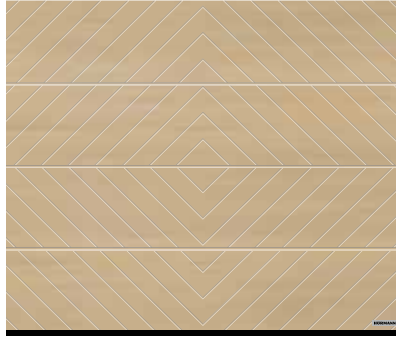

Style 402

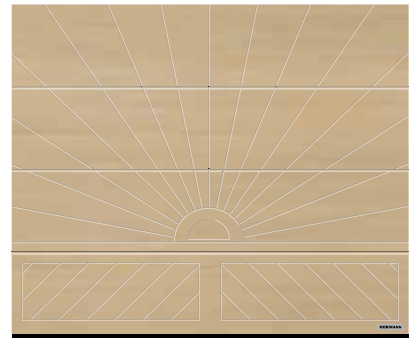

Style 403



Style 404

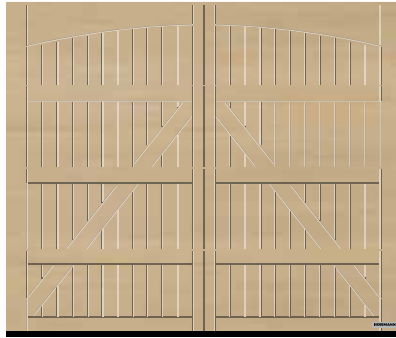

Style 405

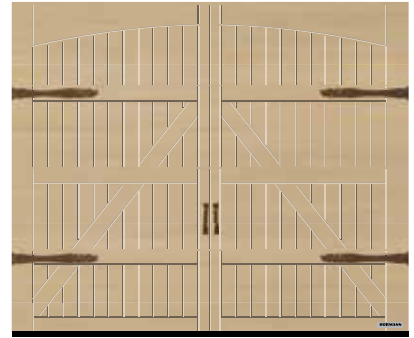

Style 405, with optional hinged door fittings "Exclusive"

Types of timber



1



2

- 1 Hemlock
- 2 Hemlock, brushed surface finish

8 types of wood preservative

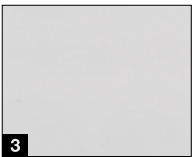

3

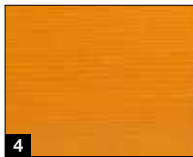

4



5

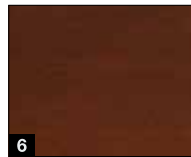

6

- 3 Limestone white, painted or opaque

- 4 Pine
- 5 Teak
- 6 Rosewood
- 7 Ebony
- 8 Agate grey
- 9 Fir green
- 10 Nordic red

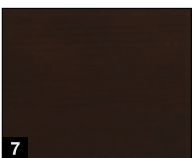

7

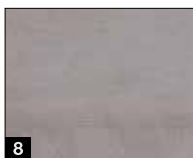

8

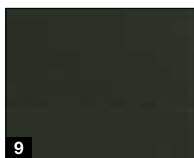

9

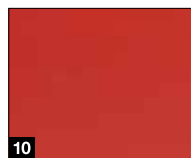

10

Glazing variants



11

- 11 V-panelled glazing V0

Standard equipment

For a secure and long-lasting door function



Tension spring assembly with multi-spring system ¹

up to 4000 mm door width or 2625 mm door height

The patented system reliably secures the door leaf from falling and prevents a broken spring from flying out and injuring people.

Torsion spring assembly with integrated spring safety device ²

from 4000 mm door width or 2625 mm door height as well as for doors with wicket door and for solid timber doors

The patented spring safety device stops the door travel immediately in the event of a spring breaking, thereby preventing the door leaf from falling.

Secure guidance of the door in safety tracks ³

Patented, adjustable rollers, sturdy roller holders and safety tracks ensure that there is no danger of the door "derailing". The door leaf is safely parked under the ceiling.

Finger trap protection ⁴

on the inside, outside and on the hinges

The unique shape of the door sections eliminates trap points, both between the sections and on the hinges.

Trap guard on the side frames ⁵

With Hörmann, the frames are completely closed from top to bottom. There are no gaps between the door leaf and frame in which fingers could get trapped!

Only from Hörmann
European patent

Plastic frame shoe ⁶

A non-brittle, 4 cm plastic frame shoe covers the frame where it is prone to rusting and offers long-term protection against corrosion, even with waterlogging, which is unmatched by competitor solutions. Together with the door's bottom seal, the frame shoe makes for a bottom edge that is visually appealing.



Optional equipment

For more convenience and security

Premium version ¹

For LPU 42, LPU 67 Thermo, ART 42 and ART 42

Thermo: For a beautiful interior view, the fittings, frames, tracks and the connection rail are painted matching the section interior in Grey white RAL 9002 ¹⁾. Tandem track rollers ensure very quiet and gentle door travel.

Ventilation slot on the topmost section ²

For LPU 67 Thermo ²⁾ and LPU 42 ²⁾ with operator SupraMatic or ProMatic (from year of manufacture 2012): The optional folding roller bracket means that you only open the top section of your door to ventilate the garage. The bottom door section remains sealed on the ground, thus offering protection against small animals or leaves.

Emergency release lock ³

For LPU 42, LTE 42 and LTH 42: To manually unlock your garage from the outside in an emergency, you can use an emergency release lock. An inconspicuous round cylinder (cannot be integrated in the master key system) is connected to the emergency release of the operator boom on the inside.

Door handle for emergency release ⁴

For all door versions: The door handle is equipped with a lock that can be integrated into the master key system. Use the handle to unlock the emergency release of the operator boom via a Bowden cable on the inside of the door. The door handles are available in the following versions: Black plastic, White cast aluminium, RAL 9016, Brushed stainless steel (see fig.), Brown cast aluminium, RAL 8028.

ThermoFrame ⁵

For all door versions: The plastic profile can be easily fitted together with the door frame, creating a thermal break between the frame and brickwork, thus improving thermal insulation by up to 15 %³⁾. In addition, extra lip seals on both sides and in the upper section of the door lower the loss of heating energy from the garage interior.

¹⁾ Galvanized spring assembly incl. holder, spring safety device, cable drum, operator boom

²⁾ Only track application N, L, Z, not possible for doors with wicket door

³⁾ For a double-skinned sectional garage door LPU 42 with the dimensions 5000 x 2250 mm



RC 2 security equipment

Standard for LPU 67 Thermo, optional for LPU 42:

The certified RC 2 security equipment makes your door even safer and is recommended by police information centres.

Further information can be found at www.k-einbruch.de



Side doors

Garage side doors NT 60 / NT 80

Door sizes*

- Width (single-leaf) 990 – 1115 mm
- Width (double-leaf) 1130 – 3000 mm
- Height (single- / double-leaf) 1990 – 2183 mm

Leaf frame

- Narrow version **1**
(Profile type 1, only for single-leaf side doors)
- Wide version **2**
(Profile type 2)

Standard equipment

- 60 mm thick weather-resistant aluminium profiles in the colour of the sections **3** or, with Duragrain infills, in a colour that matches the decor
- Traffic leaf with black plastic lever handle set with oval rose escutcheons and profile cylinder lock **4**
- 3-way adjustable hinges optionally in black, white or aluminium natural finish **5**
- Fixed bolt for locking the fixed leaf with double-leaf side doors **6**

Optional equipment

- Concealed hinges for an elegant door view in the version with aluminium block frame **7**
- Break-in resistant RC 2 security equipment with 3-point-locking (latch, bolt, 2 locking hooks) and security rose escutcheon for the version with wide leaf frame (profile type 2) **8**
- Double-leaf side doors with asymmetrical division
- Lever handle or lever / knob handle sets in aluminium natural finish **9**, cast aluminium RAL 9016 **10**, brown cast aluminium **11**, brushed stainless steel **12**



* depending on leaf frame version



Insulated version NT 80

- Aluminium profile system, frame and threshold rail with thermal break
- Depth 80 mm



Multi-purpose door MZ Thermo

- Door leaf and frame with thermal break
- Very good thermal insulation value of 1.2 W/(m²·K).
- Optionally in RC 2 version (KSI Thermo)



For further information, see the "Steel doors" brochure.

Wicket doors

With trip-free threshold

Door versions

- LPU 42 (up to 5 m door width)

Clear opening widths

- Width 830 mm
- Width 1140 mm

Standard equipment

- Aluminium door frame in anodised natural finish **1**
- Robust door catch prevents door leaf dropping and warping **2**
- Concealed hinges for a uniform door appearance **3**
- Slide rail door closer incl. integrated opening limiter and hold-open device **4**

Optional equipment

- Aluminium door frame in RAL to choose (also different from the door colour) or painted to match the colour of the decor (Planar, Decograin, Duragrain surfaces)
- Integrated door closer incl. hold-open device for optimum protection and the best appearance **5**
- Multiple-point locking with one bolt and hook per section for a better stability and improved break-in resistance **6**
- Leading photocell VL 2 stops the door without contact and increases the safety **7**



Please note:

In some cases, adjacent panelled doors with the same width, with or without a wicket door, may not have a uniform panel spacing.
Manually operated garage doors with wicket door do not have an exterior door handle. They are locked from the inside.



Door sizes

- Width 1330 – 3000 mm
- Height 1960 – 2500 mm

Standard equipment

- Door infill made of 42 mm thick sections **1**
- for S-ribbed, M-ribbed, L-ribbed, D-ribbed and T-ribbed in all colours and decors
- 60 mm thick aluminium frame profiles in section colour (for Decograin and Duragrain infills in a colour matching the decor) **2**
- 3 sturdy hinges per door leaf (one hinge secured) in aluminium colour **3**
- 3-sided double door seal and double lip seal in the threshold area **4**
- Traffic leaf with aluminium lever handle set and profile cylinder lock **5**
- Fixed leaf with door espagnolette lock **6**

Optional equipment

- Door stay for traffic and fixed leaf to fix the leaves when open **7**
- Door stay with braking and damping function to prevent the leaves from uncontrolled slamming and opening and blocking in any desired position **8**
- Concealed hinges for an elegant door appearance

Operator equipment

- Hinged door fitting incl. cover for the ProMatic 4 or SupraMatic 4 operators **9**
- Concealed hinges
- Finger guard or trap guard for a excellent safety inside **10**



Operators

SupraMatic 4

Supra-fast door opening and smart additional functions

- 75 % faster opening speed* of up to 25 cm/s
- Smart operation with the BlueSecur app
- Convenient garage ventilation
- Additional opening height
- Up to 3 times (SupraMatic E) or 5 times* (SupraMatic P) brighter LED lighting
- Easy-to-use programming thanks to 2 × 7-segment display
- High-quality stainless steel operator cover
- Networked with Smart Home systems via the standard HCP interface
- Low power consumption in standby below 1 watt



BiSecur

As standard with two 4-button hand transmitters HSE 4 BS, textured surface black with chrome caps

| Garage door operators | SupraMatic E | SupraMatic P |
|-----------------------|--|--|
| Bluetooth receiver | Integrated, can be switched on and off | Integrated, can be switched on and off |
| HCP bus connection | Integrated | Integrated |
| Cycles per day / hour | 25 / 10 | 50 / 10 |
| Pull and push force | 650 N | 750 N |
| Peak force | 800 N | 1000 N |
| Max. opening speed | 25 cm/s ²⁾ | 25 cm/s ²⁾ |
| Lighting | 20 LEDs | 30 LED chase light |
| Max. door width | 5500 mm | 6000 mm |
| Max. door surface | 13.75 m ² | 15 m ² |

* in comparison with the ProMatic series 3

Only from Hörmann
European patent

Bluetooth Hörmann BlueSecur

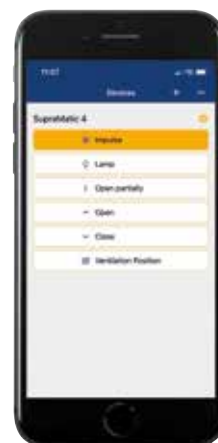

Operation by smartphone using the Hörmann BlueSecur app

Premium quality at an attractive price

- 40 % faster opening speed * of up to 20 cm/s
- Convenient garage ventilation
- Additional opening height
- Up to 2 times * brighter LED lighting
- Networked with Smart Home systems via the standard HCP interface
- Low power consumption in standby below 1 watt



 **BiSecur**

As standard with two 4-button hand transmitters HSE 4 BS, textured surface black with plastic caps

| Garage door operators | ProMatic 4 | ProMatic 4 Akku |
|-----------------------|----------------------|--------------------|
| Bluetooth receiver | Optional (HET-BLE) | Optional (HET-BLE) |
| HCP bus connection | Integrated | Integrated |
| Cycles per day / hour | 25 / 10 | 5 / 2 |
| Pull and push force | 600 N | 500 N |
| Peak force | 750 N | 600 N |
| Max. opening speed | 20 cm/s | 16 cm/s |
| Lighting | 10 LEDs | 10 LEDs |
| Max. door width | 5000 mm | 4000 mm |
| Max. door surface | 11.25 m ² | 9 m ² |

ProMatic 4 Akku

For garages without power connection



Battery with solar module

Accessories

Hand transmitter



HS 5 BS
4 button functions, plus query button, high-gloss surface black or white



HS 5 BS
4 button functions, plus query button, textured surface black matt



HS 4 BS
4 button functions, textured surface matt black



HS 1 BS
1 button function, textured surface matt black



HSE 1 BS
1 button function, including eyelet for key ring, textured surface matt black



HSE 4 BS
4 button functions, incl. eyelet for key ring, textured surface matt black with chrome or plastic caps



HSE 4 BS
4 button functions, incl. eyelet for key ring
High-gloss surface with chrome caps, colours (shown from left): Anthracite grey, Frozen grey, Classic grey, Carbon, Silver ■ **NEW**



HSD 2-C BS
High-gloss chrome, 2 button functions, can also be used as a key ring



HSZ 1 BS
1 button function, for insertion in vehicle cigarette lighter



Hand transmitter station
In high-gloss surface black or white, textured surface matt black for HS 5 BS, HS 4 BS, HS 1 BS



Hand transmitter holder
For wall fitting or fastening to the sun visor of a car, transparent, for HS 5 BS, HS 4 BS, HS 1 BS as well as HSE 1 BS and HSE 4 BS

→ The complete range of accessories can be found in the “Door operators and Smart Home systems” brochure.



Radio code switch FCT 3 BS
3 functions, with illuminated buttons, recessed or surface-mounted fitting possible, plastic housing in Light grey 7040 (also available with 10 functions and hinged cover, painted in White aluminium RAL 9006)



Radio code switch FCT 10 BS
10 functions, with illuminated buttons and hinged cover, recessed or surface-mounted fitting possible, plastic housing in White aluminium RAL 9006



Radio finger-scan FFL 25 BS
2 functions and up to 25 fingerprints, with hinged cover, recessed and surface-mounted fitting possible, plastic housing painted in White aluminium RAL 9006



Radio internal push button FIT 5 BS
4 button functions plus query button, plastic housing in Pure white RAL 9010

Button



Radio internal push button FIT 2-1 BS
2 functions, connection option for max. 2 control elements via cable, e.g. key switch, plastic housing in Pure white RAL 9010



Internal push button IT 1b-1
Large, illuminated button for convenient opening of the door, plastic housing in Pure white RAL 9010



Transponder key switch TTR 1000-1
1 function, 1000 teachable keys, scope of delivery: 1 key and 1 card (more on request), zinc die-cast housing in White aluminium RAL 9006



Code switch CTP 3-1
3 functions, with illuminated lettering and touch-sensitive black surface, zinc die-cast housing in White aluminium RAL 9006



Code switch CTV 3-1
3 functions, particularly robust with metal keypad, zinc die-cast housing in White aluminium RAL 9006 with stainless steel panel



Finger-scan FL 150
2 functions, control via fingerprint, up to 150 savable fingerprints, zinc die-cast housing in White aluminium RAL 9006 with stainless steel panel



Key switch
1 STUP 50
2 STAP 50
Recessed version and surface-mounted version, incl. 3 keys, zinc die-cast housing in White aluminium RAL 9006 with stainless steel panel



Inside climate sensor HKSI
For monitoring humidity and automatic ventilation of the garage, plastic housing in Pure white RAL 9010

Modernisation solutions

For special fitting situations

Standard fitting **1**

Ideally, the available garage has at least 90 mm sideroom. The frame can then be screwed directly into the wall behind the opening. Hörmann sectional doors come with all the necessary fitting materials.

Frame support set ■ NEW **2**

The plastic profile is fitted between the frame and brickwork. In the case of damp exterior walls, this prevents the transfer of moisture to the frame and effectively prevents the formation of rust.

Frame coverings

For a harmonious overall appearance, the side frames with frame coverings can be easily adapted to the surface finish of the sections.

3 55 mm wide frame covering incl. adhesive pads for easy fitting behind the opening, with little sideroom (< 90 mm)

4 90 mm wide frame covering for fitting in the opening, flush with the wall

Special anchor for frame side fixing

The sectional door frame can be fitted to the side wall of the garage with Hörmann's optional, universally applicable anchors. Irregularities in the wall can be easily compensated, leaving the reveal intact.

3 Fitting with up to 35 mm wall spacing

4 Fitting with angled or irregular side wall

5 Fitting with thermal insulation composite system

6 Fitting with non-load-bearing facades (facing brick or thermal insulation) with sideroom of 90 to 125 mm and fixing depths of 160 to 240 mm (depending on the anchor version).



Wind threshold **7**

The profile is simply fitted to the floor and seals off the door bottom edge additionally. It prevents the penetration of water across the full door width. The low height ensures barrier-free access.

Compensation set for uneven floors **8**

The adjustable bottom profile compensates the bottom edge of the door leaf up to a height difference of 20 mm. The set for frame compensation consists of 2.5 mm thick plastic plates, which are positioned to fit perfectly under the frame shoes.

Replacement of up-and-over doors

When removing an old up-and-over door and fitting a new LPU 42 sectional door, a time-consuming process is often necessary to straighten the ground. With our modernisation solutions this work is no longer necessary.

Renovation threshold rail **9**

Replaces the old threshold rail of an up-and-over door for a clean seal with the garage floor.

Recess set **10**

The set consists of a compensation profile and special track applications. The frame must be shortened by 25 mm if the set is used. This can either be ordered in the desired dimensions or shortened on site.

Reno RZ set ■ NEW **11**

The rear part of the plastic frame shoe is notched so that it can be fitted on the floor rail of the old up-and-over door. The set consists of a special buffer piece and a specially shaped bottom seal that neatly seals the door in front of the threshold rail.

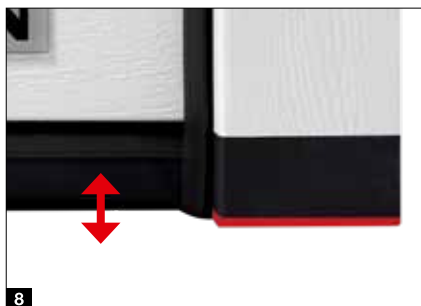

Modernisation solutions

With elegant panels

Fascia panel ¹

Ideally, the available garage has at least 100 mm of clearance in the lintel area (at least 115 mm for doors with operator). The fascia panel for standard fitting behind the opening is supplied with a height of 95 mm as standard. The panel is also available with a height of 125 mm on request.

Double-skinned fascia panel ²

A matching, double-skinned fascia panel for fitting in the opening covers a larger gap between the ceiling and the standard fascia panel. Glazings are also possible after technical clarification. This panel can be optionally supplied as an aluminium light strip.

Flush-fitting fascia panel ³

For LPU 42 doors, a flush-fitting fascia panel is the most elegant solution for an invisible transition between the panel and door leaf. When the door is closed, the top door section is flush with the panel.

Fascia frame set for lintel and side wall

A door in an inexpensive standard or modernisation size can be fitted in the opening. The remaining gap between the lintel and top door section or side wall and side frame (max. 35 mm) is covered using an optional fascia frame set. This set comes with fascia panels, end caps and fixing materials. The side frame is additionally covered with an optional frame covering:

⁴ 95 mm width for fitting in the reveal

⁵ 125 mm width for fitting in front of the reveal.

Retrofit fascia set ⁶

Unattractive gaps and broken masonry in the lintel and reveal can be covered easily and neatly with the optional retrofit fascia. Additional brickwork and plastering work are no longer required.



| | Woodgrain | Slategrain | Silkgrain | Sandgrain | Planar | Decograin | Duragrain |
|----------------------------|-----------|------------|-----------|-----------|--------|-----------|-----------|
| Frame covering | ● | ○ | ● | ● | ● | ● | □ |
| Fascia panel | ● | ○ | ● | ● | ● | ● | □ |
| Fascia panels | ● | ● | ● | ● | ● | ● | ● |
| Fascia frame set | ● | ○ | ● | ● | ● | ● | □ |
| Flush-fitting fascia panel | ● | ● | ● | ● | ● | ● | ● |
| Retrofit fascia set | ● | ○ | ● | ● | ● | ● | □ |

- = Covering / panels and door sections in the same surface finish, colour, or decor
- = Covering / panels with smooth surface finish and in the same colour as the door section
- = Covering / panels with smooth surface finish and in a colour matching the door section or in RAL to choose



Vertical views (with operator)

Track application Z

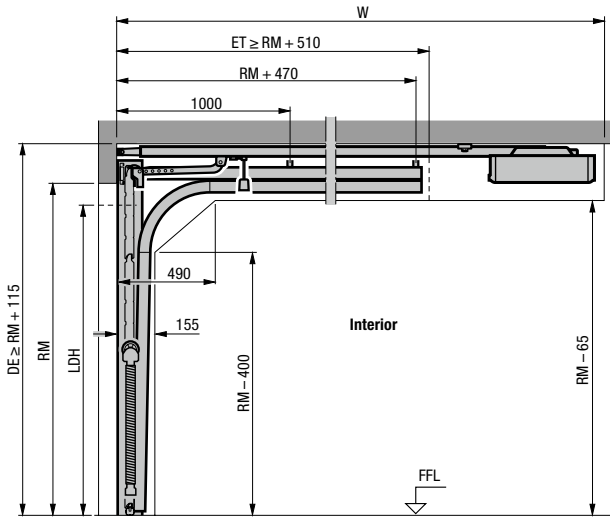

Track application N

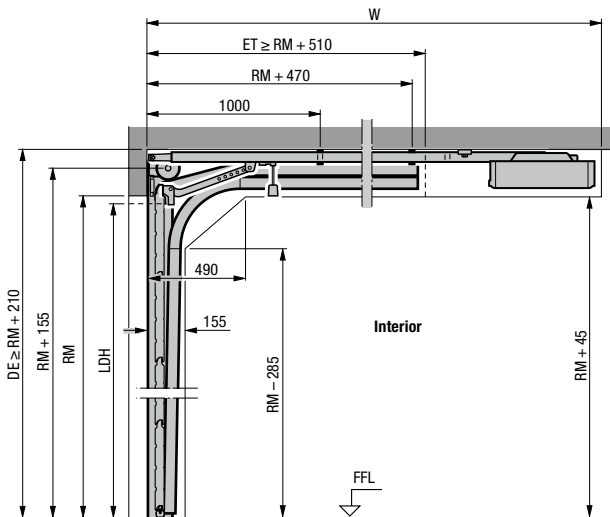

Track application L

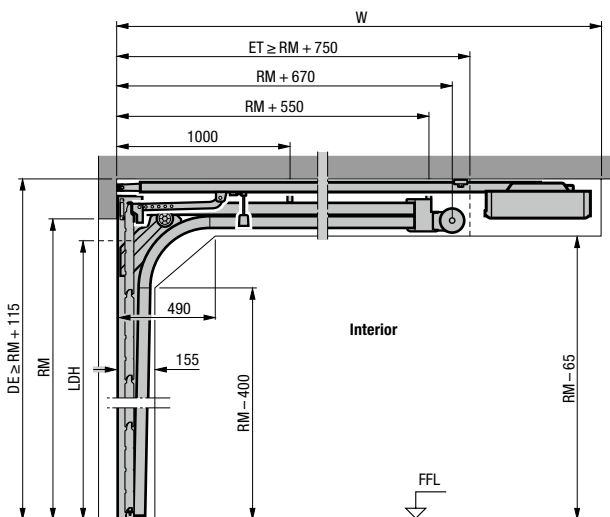

Horizontal view

Track application Z, N, L

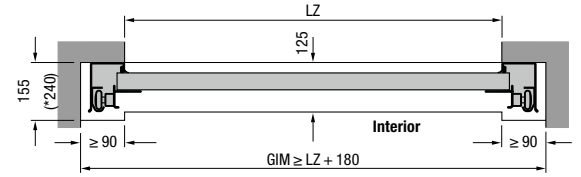

Fitting with track applications Z, N, L

| Overall length operators (W) | Track application Z | Track application N | Track application L |
|------------------------------|---------------------|---------------------|---------------------|
| Doors with operator | | | |
| | 2125 (K) | 3200 | 3200 ¹⁾ |
| | 2250 (K) | | 3200 ²⁾ |
| Max. door height | 2375 (M) | 3450 | 3450 ¹⁾ |
| | 2500 (M) | | 3450 ²⁾ |
| | 2625 (L) | 4125 | |
| | 3000 (L) | 4125 | 4125 |

¹⁾ Max. door height only for LPU 67 Thermo

²⁾ Max. door height only for LPU 42, LTE 42

Explanations

Operator booms

- K Short boom
- M Medium boom
- L Long boom

Ordering sizes

- LZ Clear frame dimension
- RM Grid height
- DE Ceiling height
- W Overall length with operator
- LDH Clear passage height
- GIM Inside garage dimension
- ET Distance back

Note:

The operator should be fitted 40 mm higher for dark coloured doors which are exposed to the sun.

For track applications such as high-lift track applications as well as further information, please see the technical manual or contact your Hörmann partner.

Dimensions and fitting data

Side doors

Solid timber and steel side doors – horizontal views

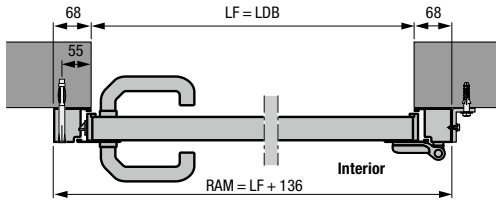

Side door with aluminium block frame, profile type 1
Fitting behind the opening

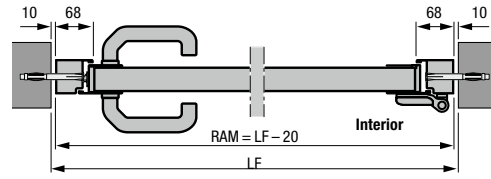

Side door with aluminium block frame, profile type 2
Fitting in the opening

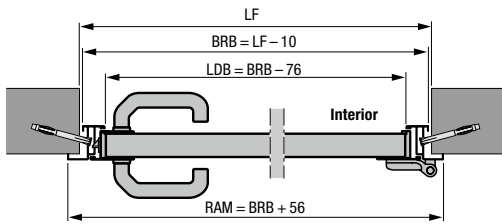

Side door with aluminium corner frame,
profile type 1 or 2
Internal fitting

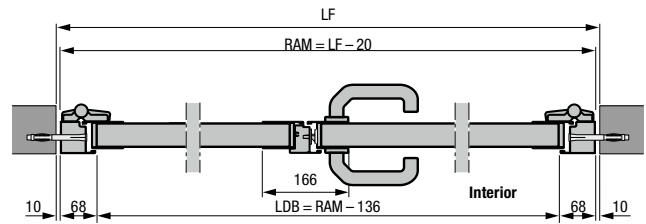

Double-leaf side door with aluminium block frame, profile type 2
Fitting in the opening

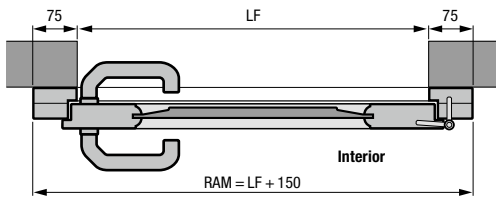

Solid timber side door
Fitting behind the opening

- Double-leaf side door with asymmetrical division
- Double-leaf side door opening inwards and outwards

Solid timber and steel side doors – vertical views

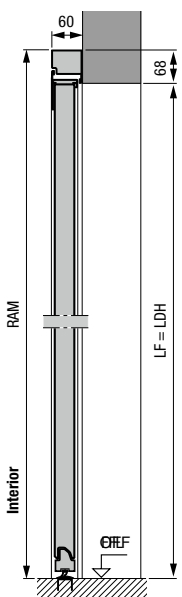

Side door with aluminium block frame, profile type 2
Fitting behind the opening

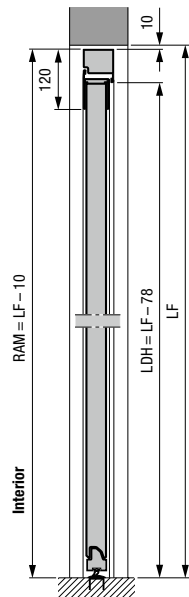

Side door with aluminium block frame, profile type 2
Fitting in the opening

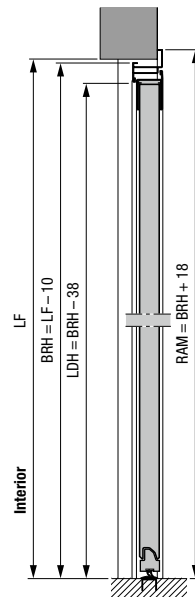

Side door with aluminium corner frame, profile type 2
External fitting

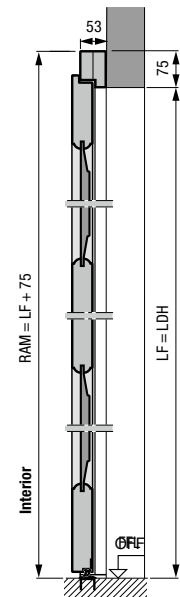

Solid timber side door
Fitting behind the opening

Steel side doors

Profile type 1 (fitting behind the opening) with S-, M-, L-ribbing, S-panelled, block frame

| LF of the opening | Ordering size = RAM | Lever height* from FFL | Door section height B |
|--------------------------|---------------------|------------------------|-----------------------|
| 855 – 875 × 1990 – 2000 | 990 × 2058 | 955 | 500 |
| 855 – 875 × 2115 – 2125 | 990 × 2183 | 1010 | 531 |
| 980 – 1000 × 1990 – 2000 | 1115 × 2058 | 955 | 500 |
| 980 – 1000 × 2115 – 2125 | 1115 × 2183 | 1010 | 531 |

Profile type 2 (fitting behind the opening) with S-, M-, L-, D-, T-ribbing, S-panelled, block frame

| LF of the opening | Ordering size = RAM | Lever height* from FFL | Door section height B |
|--------------------------|---------------------|------------------------|-----------------------|
| 855 – 875 × 1990 – 2000 | 990 × 2058 | 1050 | 500 |
| 855 – 875 × 2115 – 2125 | 990 × 2183 | 1050 | 531 |
| 980 – 1000 × 1990 – 2000 | 1115 × 2058 | 1050 | 500 |
| 980 – 1000 × 2115 – 2125 | 1115 × 2183 | 1050 | 531 |

Profile type 2 (fitting in the opening) with S-, M-, L-, D-, T-ribbing, block frame

| LF of the opening | Ordering size = RAM | Lever height* from FFL | Door section height B |
|-------------------|---------------------|------------------------|-----------------------|
| 875 × 2000 | 855 × 1990 | 1050 | 500 |
| 875 × 2125 | 855 × 2115 | 1050 | 531 |
| 1000 × 2000 | 980 × 1990 | 1050 | 500 |
| 1000 × 2125 | 980 × 2115 | 1050 | 531 |

Profile type 1 (only opening inwards, internal fitting) with S-, M-, L-ribbing, S-panelled, corner frame

| Ordering size = BRM | Lever height* from FFL | Door section height B |
|---------------------|------------------------|-----------------------|
| 875 × 2000 | 955 | 500 |
| 875 × 2125 | 1010 | 531 |
| 1000 × 2000 | 955 | 500 |
| 1000 × 2125 | 1010 | 531 |

Profile type 2 (internal or external fitting) with S-, M-, L-, D-, T-ribbing, corner frame

| Ordering size = BRM | Lever height* from FFL | Door section height B |
|---------------------|------------------------|-----------------------|
| 875 × 2000 | 1050 | 500 |
| 875 × 2125 | 1050 | 531 |
| 1000 × 2000 | 1050 | 500 |
| 1000 × 2125 | 1050 | 531 |

Solid timber side doors

Fitting behind the opening (S-, M-, L-ribbed, panelled)

| Ordering size = RAM | LF of the opening | Lever height* from FFL |
|---------------------|--------------------------|------------------------|
| 1005 × 2190 | 855 – 875 × 2115 – 2125 | 1050 |
| 1130 × 2190 | 980 – 1000 × 2115 – 2125 | 1050 |

Fitting behind the opening (style 401, 403, 404, 405)

| Ordering size = RAM | LF of the opening | Lever height* from FFL |
|---------------------|--------------------------|------------------------|
| 1130 × 2190 | 980 – 1000 × 2115 – 2125 | 1050 |

Explanations

| | |
|------------|------------------------------------|
| P1 | Profile type 1 (narrow leaf frame) |
| P2 | Profile type 2 (wide leaf frame) |
| LDB | Clear passage width |
| LDH | Clear passage height |
| RAM | Overall frame dimension |
| LF | Structural opening |
| BRM | Nominal size |
| BRB | Nominal size – width |
| BRH | Nominal size – height |
| FFL | Finished floor level |

Special sizes

Single-leaf side doors:
on request

Double-leaf side doors:
1330 – 2500 × 1960 – 2558 mm

* You can find the lever heights for special sizes in the technical manual.

For further information, please see the technical manual or contact your Hörmann partner.

Experience Hörmann quality in new construction and modernisation

Hörmann provides an excellent basis for comprehensive planning. Carefully matched solutions offer you the very best in perfectly designed products for every area.

**GARAGE DOORS. GATE AND DOOR OPERATORS. ENTRANCE DOORS.
RESIDENTIAL INTERNAL DOORS. STEEL DOORS. FRAMES.**



Some of the doors shown are equipped with optional extras and do not always correspond to the standard versions. The surface finishes and colours shown are subject to the limitations of the printing process and cannot be regarded as binding. All rights reserved. No part may be reproduced without our prior permission. Subject to changes.