



**MADE TO MEASURE HAND CRAFTED
GARAGE DOORS BRITISH MADE**

2021
selectgaragedoors.co.uk



Who we are

Established in 2000 in Bolton and now based in Walkden, Select Garage Doors has been manufacturing made to measure garage doors for garage door specialists for 21 years.

We are one of the UK's leading manufacturers of made to measure garage doors.

All doors are made by hand to your specific requirements. We offer 11 unique ranges with a wide variety of door styles and colour options.

Product Types

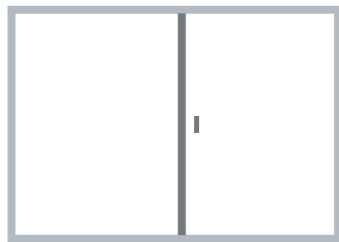

Centre Split



Off-Centre Split



Canopy

Side Hinged doors are available as **Centre Split** or **Off-Centre Split** depending on size and design. The right or the left can be the leading door and doors can open in or out. On off centre split doors the large or the small door can be the leading door. As standard doors will be supplied with a brushed steel effect night latch lock and matching brushed steel hinges. Black and brass hinges are also available but must be stated on order. Unless specified at the time of order, doors will be made with the first door opening door on the right as viewed from outside, opening out.

Canopy doors use an overhead torsion spring and vertical tracks fixed directly to the frame. The lack of ceiling suspended tracks allow for full drive-thru clearance. Multi point locking with euro profile lock centred in the top third of the door.

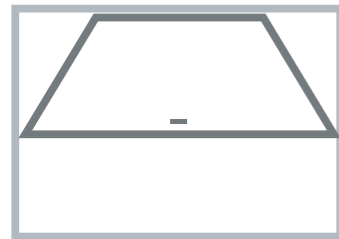

Retractable



Bi-Fold



Personnel

Retractable doors offer smooth operation and balance, ideal for electric automation. Secured with a 2-point slam latch with euro lock handle. Overhead tracks are required for this frame type. Wicket doors are an optional extra in the Rivington design.

Bi-folds are available on most side hinged door designs. They can open back-to-back or face-to-face and either in or out. They are available in our powder coat and laminate finishes. Where a door has a centre split only the slave door can bi-fold.

Personnel doors can be hinged on either side and can open in or out. Unless specified at the time of order doors will be made with the hinges on the left as viewed from outside opening out with brushed steel night latch and matching hinges.

For more details on all our products please see our website www.selectgaragedoors.co.uk

Colour Range

Price Range A	Price Range B		Woodgrain Laminates
6005 Moss Green	1015 Light Ivory	6009 Fir Green	Golden Oak Laminate
7016 Anthracite Grey	1023 Traffic Yellow	7011 Iron Grey	Rose Wood Laminate
9005 Jet Black	3003 Ruby Red	7021 Black Grey	
9016 Signal White	3020 Traffic Red	7032 Pebble Grey	
BS-08-B-29 Vandyke Brown	5005 Signal Blue	7035 Light Grey	
	5011 Steel Blue	BS-00-A-05 Goose Grey	
	5013 Cobalt Blue	BS-04-E-53 Poppy Red	
	5015 Sky Blue	BS-14-C-35 Chartwell Green	
	5021 Water Blue		

SAMPLES ARE AVAILABLE ON REQUEST.

All fully finished doors are supplied in ripple finish.

We can supply different RAL colours POA.

Woodgrain Laminates are not available for the Litebecks or any products on pages 8 & 9.

COLOURS MAY HAVE VARIATIONS BETWEEN DIFFERENT BATCHES

Litebeck

Litebecks are variants of the Bowdon, Carmel and Rivington ranges that include windows in the door.

Decraglass, Decralead Glass and **Plain Obscured Glass** are all available with a wide range of style options, see page 10 for details.



Personnel

Our **Personnel** doors can be used for a range of applications, whether you want a matching side door for your garage, or need some added security for a shed or annex.

All door designs are available in Personnel versions.





Rivington range

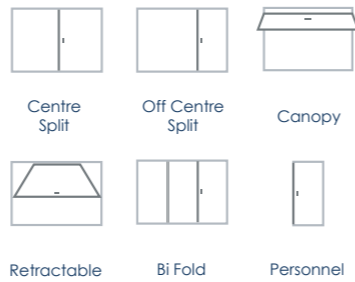

Cartmel range

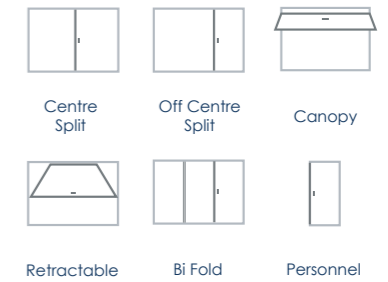

Adlington range

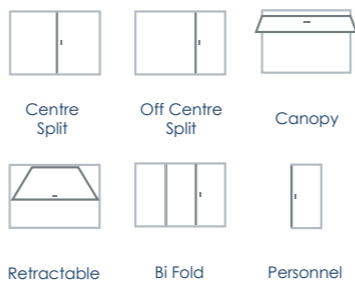

Litebeck range

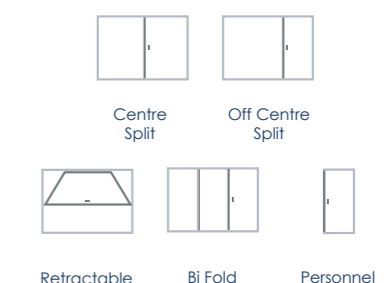
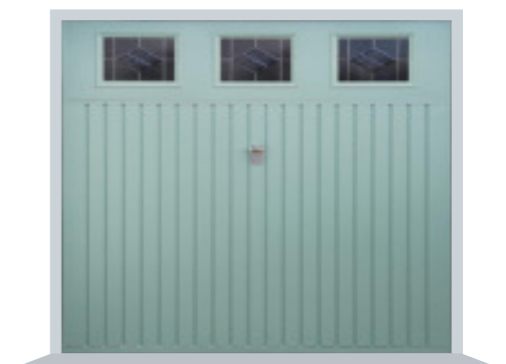

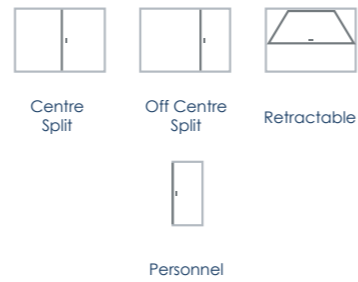

Belmont range

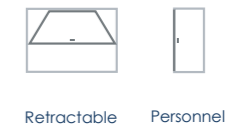

Croston range

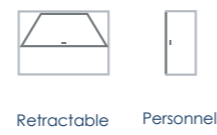
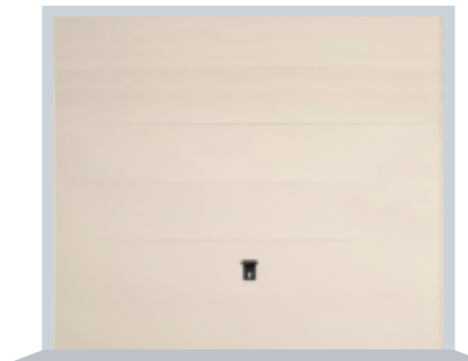

Rufford range

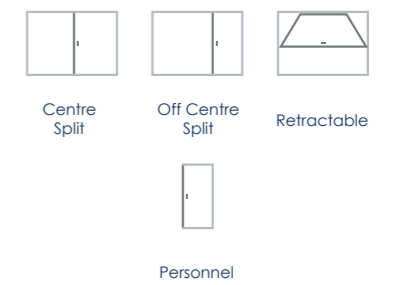
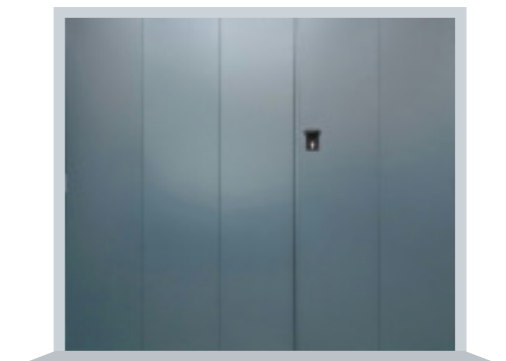

Gisburn range



Bowdon range

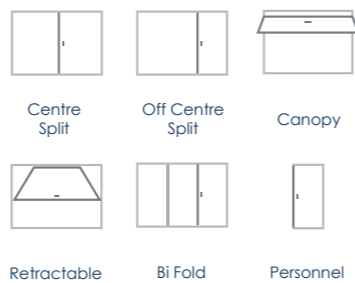

Langdale range

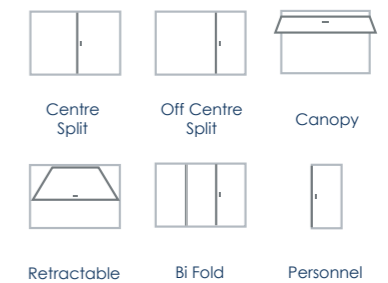

Derwent range

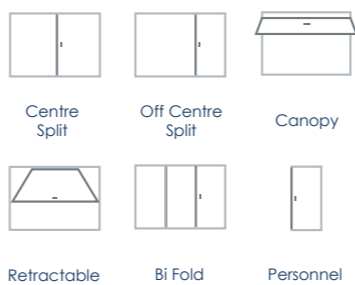

Rivington Wicket range



New window frame system

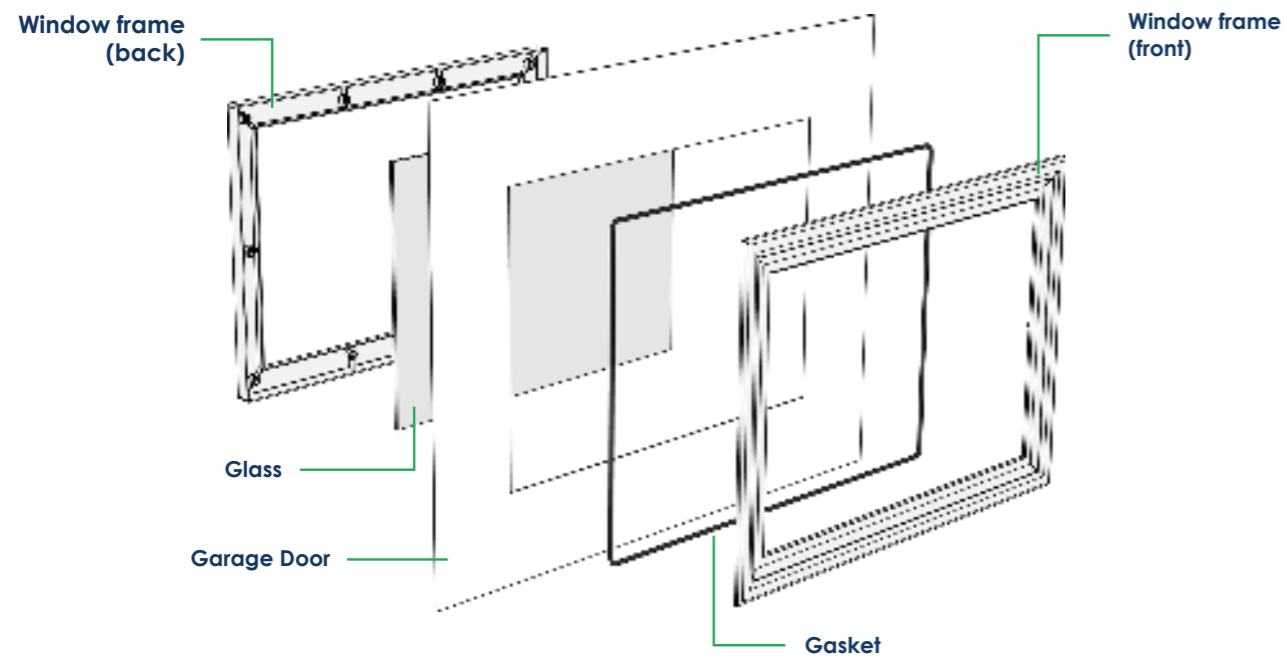

Windows for Lifebeck Doors

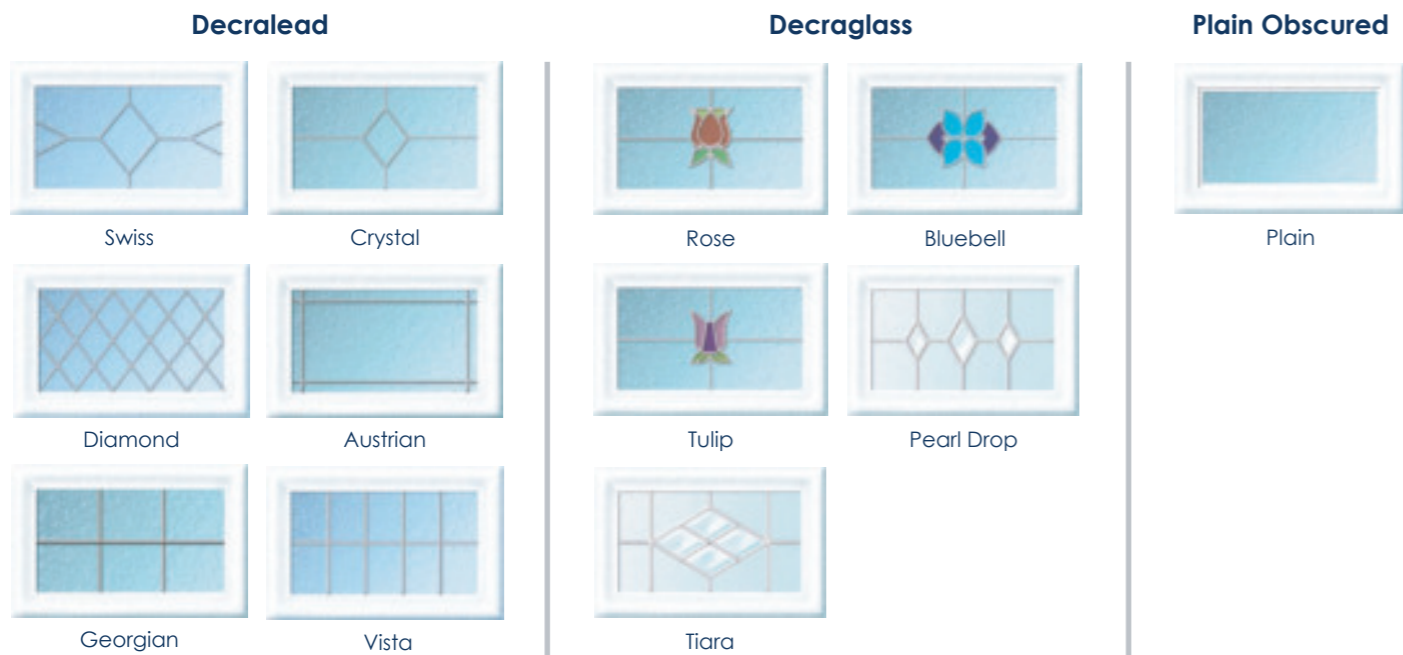

WINDOWS ARE ONLY AVAILABLE FOR THE RIVINGTON, CARTMEL AND BOWDON RANGES
 BESPOKE DESIGNS AVAILABLE ON REQUEST
 WINDOW FRAMES NOT AVAILABLE IN WOOD GRAIN

Frame Detail

All doors up to 3658mm (12ft) are available with a pre-fitted steel frame. These are finished in one of our powder coated colours and offers a strong low maintenance alternative to timber. See diagram for frame dimensions.

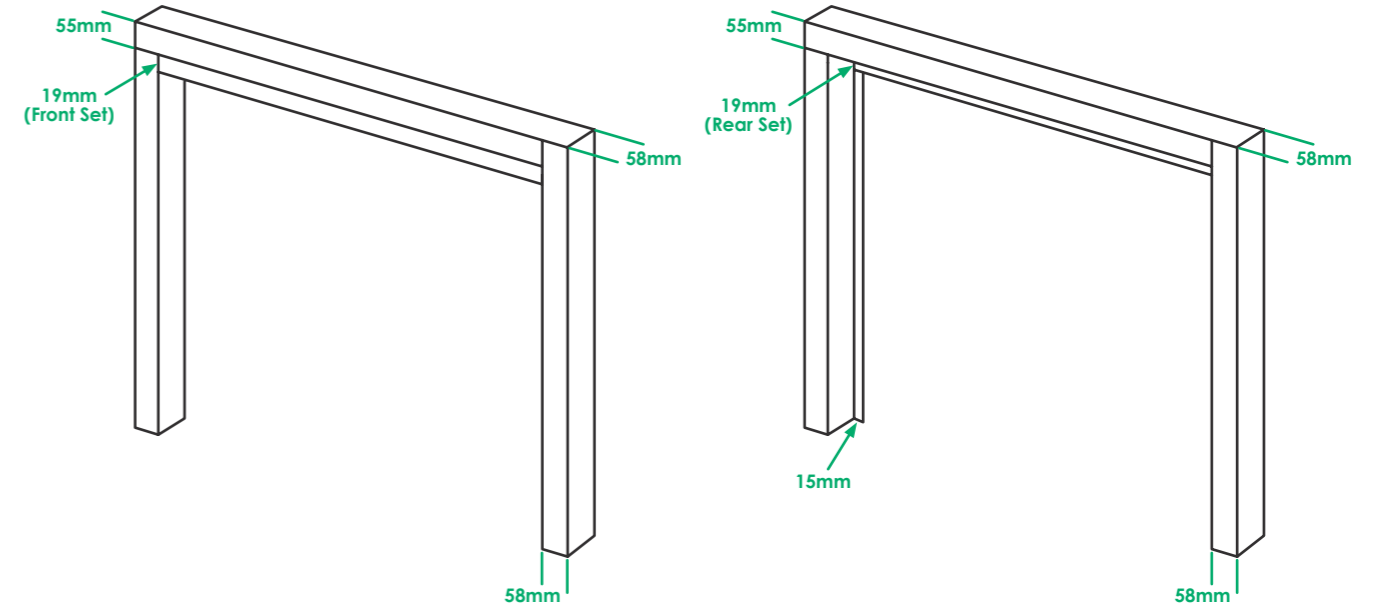

Canopy/Retract Frame

Side Hinge Frame

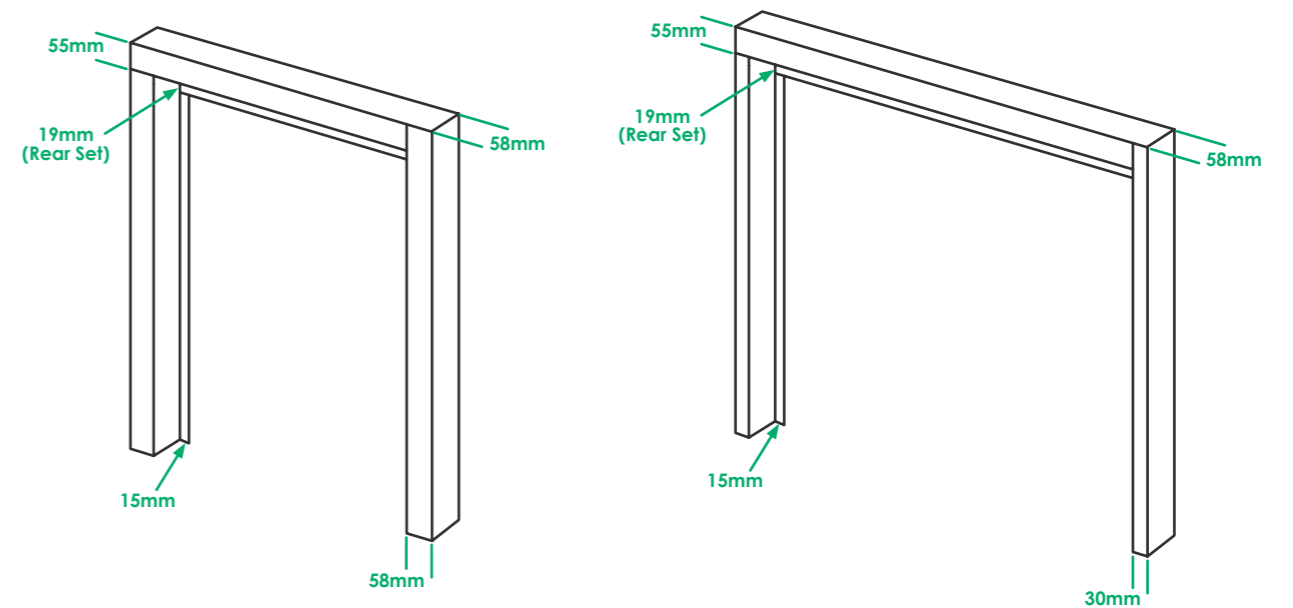

Personnel Frame

Side Hinge Frame
Narrow frame option

Additional Extras

With our additional extras you can enhance the appearance of your garage door.



Window options
Tiara shown below.
*See page 10 for all options



Hinge options

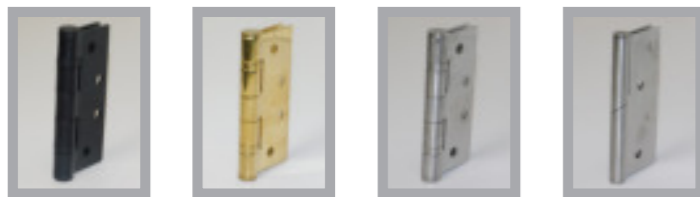

Large Black Large Brass Brushed Steel Rising Butt

Lock options



Handle Black Handle Brass Handle Brushed Steel



Rollerbolt Brass Rollerbolt Brushed Steel

COLOURS AND FINISHES OF HANDLES AND HINGES WILL BE MATCHED UNLESS STATED OTHERWISE AT THE TIME OF ORDER.

Euro Lock

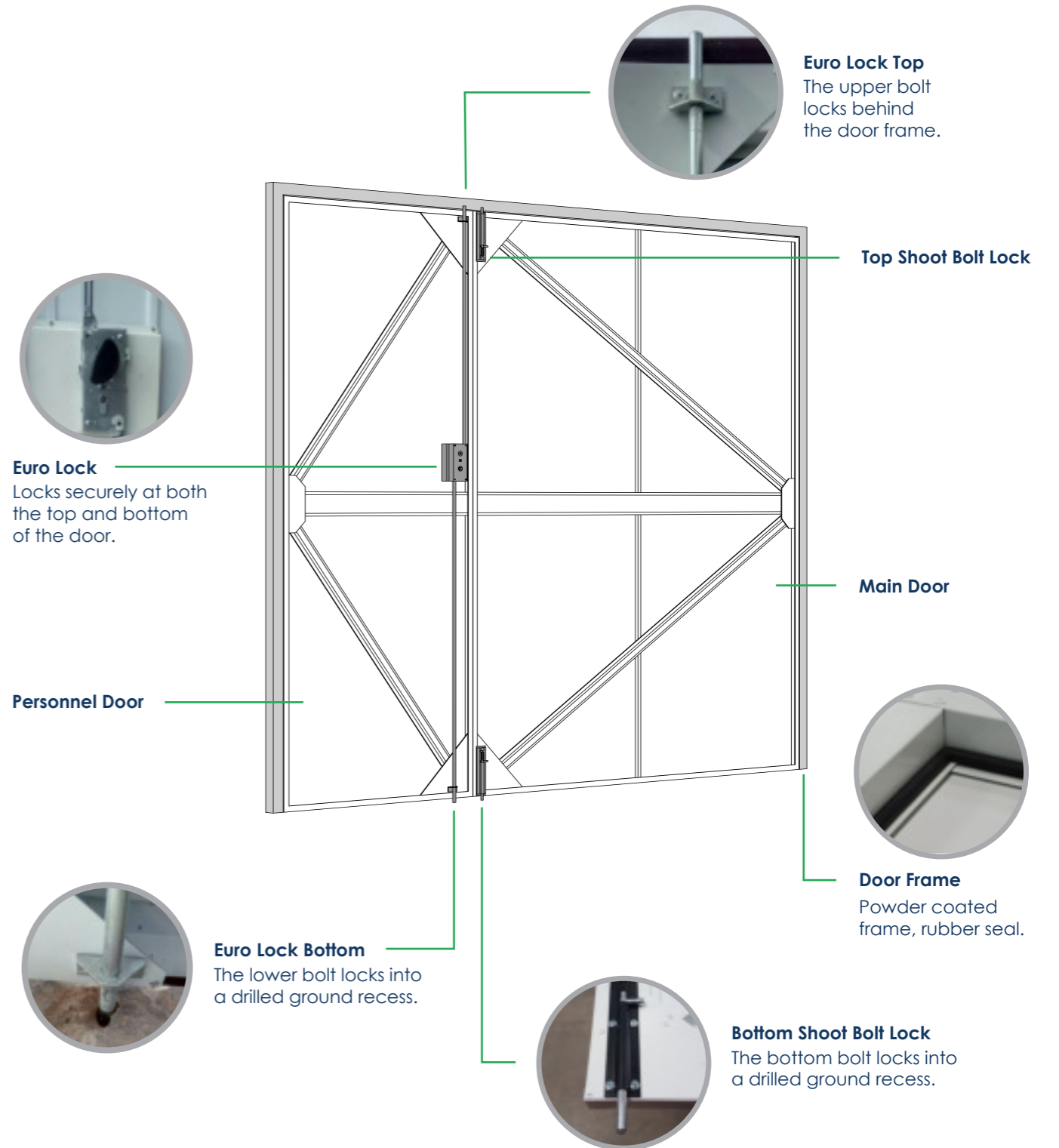

Gear projections and clearance data sheet

Canopy

	1980mm (6'6")	2314mm (7'0")
A	610	763
B	1285	1285
C	1857	2010

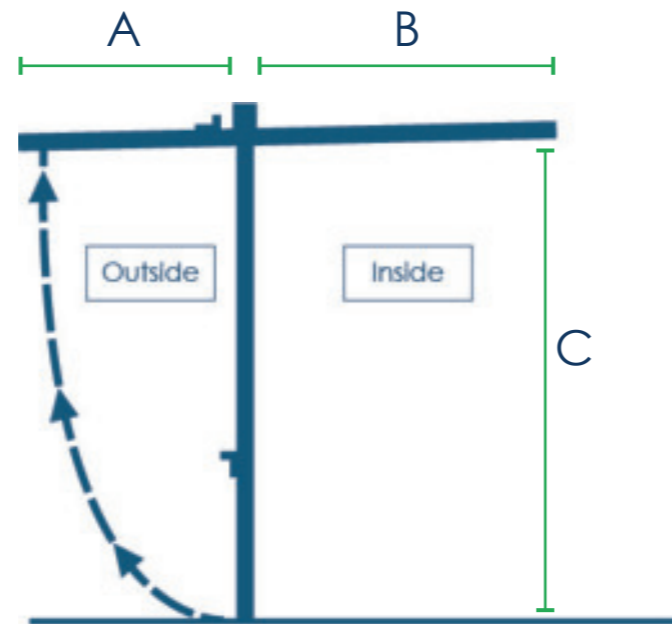

Retractable

A) Projection in front of the opening from the door face.

B) Projection into the garage from REAR of the door frame.

C) Height clearance inside the garage excluding any lock projections and deep bracing on double doors.

D) Kick up inside the garage above bottom edge of frame.

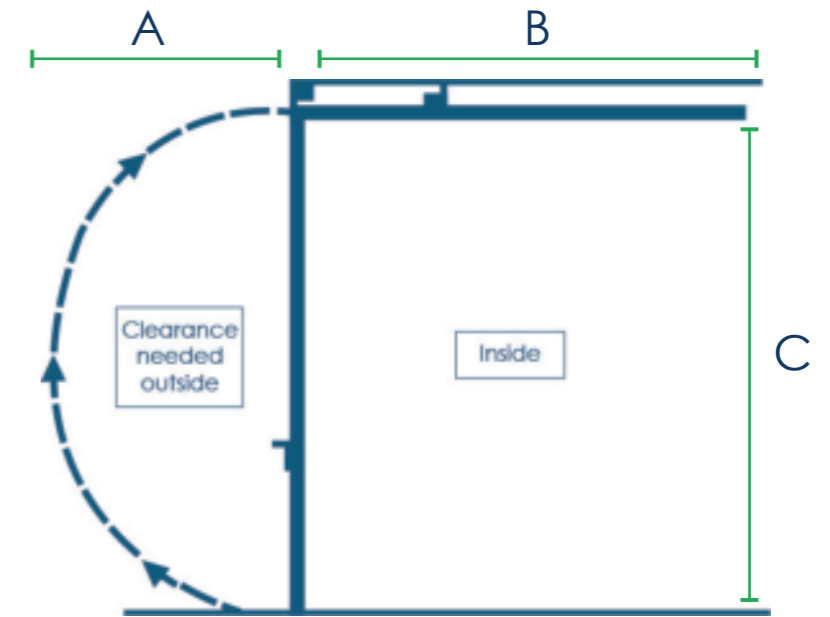

Side Hinged

A) 125mm

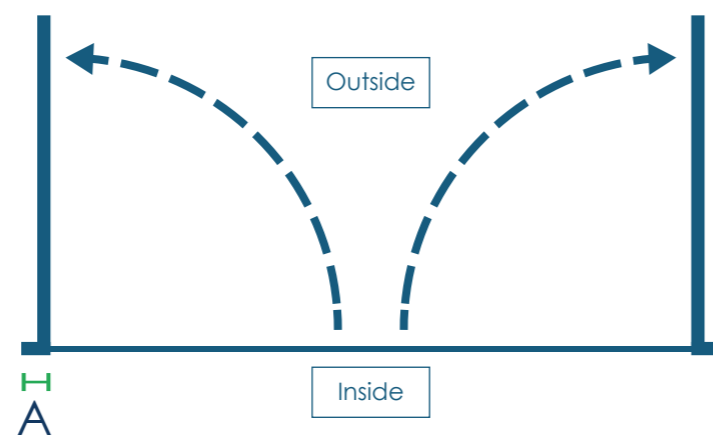

AP130

	1980mm (6'6")	2314mm (7'0")
A	990	1040
B	45	45

A) Height to the bottom of the lifting arm.

B) Projection of the lifting arm into the opening from the edge of the frame above height A.

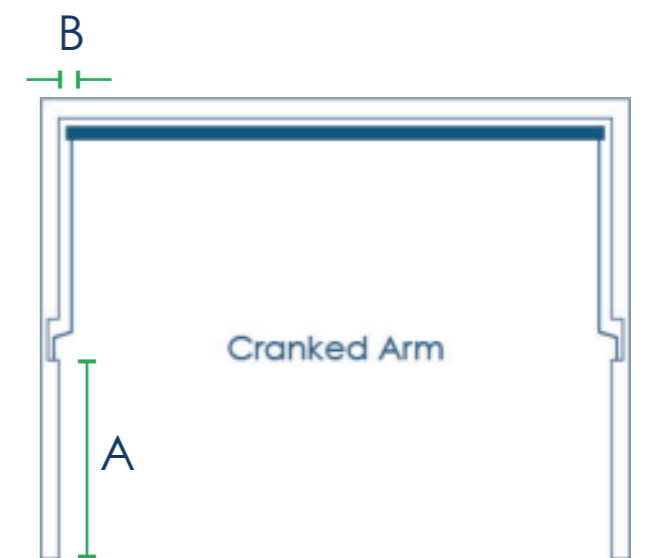

Select Steel Warranty

Select Garage Doors Ltd provides a five year limited warranty against manufacturing defects from date of purchase. In the vent of a claim, please contact the distributor who originally supplied the product, who will then supply details of the claim along with proof of purchase to Select Garage Doors Ltd. Valid claims will be repaired or replaced at our discretion.

Operating gear

All product must be installed in accordance with installation instructions. Moving parts should be lubricated 3 To 4 times a year to ensure smooth operation. A qualified engineer must inspect and carry out repairs/replacements as necessary. DO NOT ATTEMPT THIS YOURSELF, AS THIS COULD BE POTENTIALLY DANGEROUS.

Appearance

During the manufacturing process it is possible that some distortion in the panels may occur. A visual inspection should be carried out in natural daylight (not direct sunlight) from a distance of 3 metres to view the overall appearance, minor marks and blemishes not seen from this distance will not be covered by warranty.

Finish Warranty

Primed steel doors must receive a suitable exterior topcoat immediately after installation. This coating is not covered by warranty.

Factory finished powder coating is covered for 5 years. Laminate wood grain finish is covered for 5 years. Surfaces must be freely exposed to washing by rainfall and kept clear of birds droppings, accumulated dirt and debris. The door and frame should be kept free from impact damage, scratches and other surface abrasion. Damage, corrosion or discolouration caused by contact with an excessively salty atmosphere, abnormal elements within the building or from pollution, chemicals, or caustic substances are excluded from warranty.

Cleaning

Cleaning should be carried out with a soft, non abrasive sponge and clean water.

The company reserves the right to make alterations in design and manufacture as are deemed necessary without notification.

Note:

Our products are not suitable for use as gates on external installations.



2021

selectgaragedoors.co.uk